

ESTANFI
AUTOMOCION

BRITPART
ESPAÑA

ESPECIALISTAS EN LAND ROVER, 4x4 y TRANSMISIONES

CATÁLOGO DE CRUCETAS

Publicación N.º C-77 Edición 2020

CRUCETA / JOINT
SEKIDO
CRUCETA / JOINT

Para todos los modelos 4x4



Novedad
ESTANFI

Para agrícola, industrial, camión y dirección



ESTANFI - TU ESPECIALISTA EN CRUCETAS PARA 4x4 E INDUSTRIAL

INDICE
CRUCETAS PARA 4x4 3
CRUCETAS AGRÍCOLA, INDUSTRIAL, CAMIÓN y DIRECCIÓN 17
Indice crucetas 4x4 por medidas

Medidas	Ref.	Pág.	Medidas	Ref.	Pág.
41 x 16 mm	66-0H-H04	4	80 x 28 mm	66-03-305	9
54,6 x 20 mm	66-06-602	3	80,6 x 25 mm	66-01-111	10
58 x 20 mm	66-08-806	13	81 x 28 mm	66-01-102	10
58 x 20 mm	66-02-204	14	81,5 x 30 mm	66-00-006	6
58 x 22,5 mm	66-06-601	3	81,6 x 27 mm	66-00-005	4, 6, 12 y 15
61 x 20 mm	66-08-804	13	81,8 x 27 mm	66-00-099	6 y 12
62 x 23,8 mm	TVF100000	8	82 x 27 mm	66-03-303	3
62 x 23,8 mm	66-01-106	11	82 x 27 mm	66-00-098	6
62 x 24 mm	27200-85C00	5, 11 y 13	82 x 27 mm	541858	7
62 x 27 mm	66-0H-H01	4	82 x 27 mm	66-03-303	9
64 x 25 mm	66-03-304	9	82 x 27 mm	66-01-109	11
64 x 25 mm	27200-83812	9	82 x 27,5 mm	8126636	6
64 x 25 mm	66-05-504	10	82,5 x 27,2 mm	8126614	6 y 15
64 x 25 mm	66-08-801	11 y 13	83 x 27 mm	EST1046001	12
64 x 25 mm	66-08-805	13	83 x 27 mm	66-02-207	14
64 x 27,3 mm	8126610	6	83 x 30,5 mm	8126638	6
65 x 22 mm	66-04-400	3	85 x 27 mm	66-01-103	11
66 x 25 mm	66-01-110	11	85 x 27 mm	66-01-105	11
67 x 26 mm	66-02-209	14	85 x 30 mm	66-05-502	9
70 x 26 mm	66-08-802	13	87 x 27 mm	193738	7
71 x 26 mm	66-08-803	13	87 x 27 mm	193742	7
71,4 x 26,4 mm	66-0K-K00	7	92 x 27 mm	66-03-300	3 y 9
72 x 27 mm	66-01-101	10	92 x 27 mm	4746936	3, 6 y 9
74 x 24 mm	66-03-301	9	92 x 27 mm	66-01-108	6 y 11
74 x 27 mm	242521	7	92 x 30,2 mm	TVC500010	8
74,5 x 27 mm	RTC3458	8	92 x 32 mm	66-0K-K01	7
75 x 27 mm	RTC3458	8	92 x 32 mm	04371-36021	14
75 x 27 mm	RTC3458G	8	92,9 x 31,8 mm	66-02-202	14
75 x 27 mm	RTC4587	8	94 x 28,6 mm	66-0W-W00	4
75 x 27 mm	27200-86CT0	12	94 x 28,6 mm	66-00-007	6
76 x 27 mm	66-05-505	10	94 x 33 mm	66-09-906	5
76 x 27 mm	66-01-107	11	95 x 27 mm	STC4807	7
76 x 29 mm	66-09-901	4	95 x 27 mm	STC4807G	7
77 x 29 mm	66-09-912	5	96 x 29 mm	66-09-902	5
77 x 29 mm	66-09-905	12 y 15	96 x 29 mm	66-09-908	4
77 x 29 mm	66-02-205	14	96,5 x 33 mm	66-02-206	14
77,5 x 29 mm	66-02-200	4 y 14	98 x 32 mm	66-01-104	11
77,8 x 24,9 mm	66-05-501	9	99 x 35 mm	66-02-208	14
78 x 29 mm	66-02-203	4 y 14	101 x 30 mm	66-05-503	10
79,6 x 26 mm	66-02-201	14	102 x 31,7 mm	66-05-506	10
79,7 x 27 mm	66-0H-H00	4	104 x 33 mm	66-09-907	5
80 x 28 mm	66-06-600	3			

Rocky, Taft,
Feroza

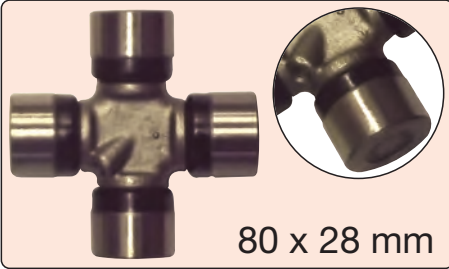

Ref.: 66-06-600
Ref. OE: 04371-87303 / K201-12-205

Feroza

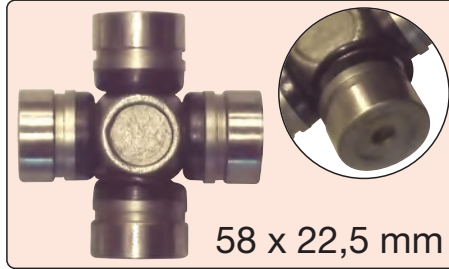

Ref.: 66-06-601
Ref. OE: 04371-87604

Hijet Furgonato
Hijet Pick-Up 1.0

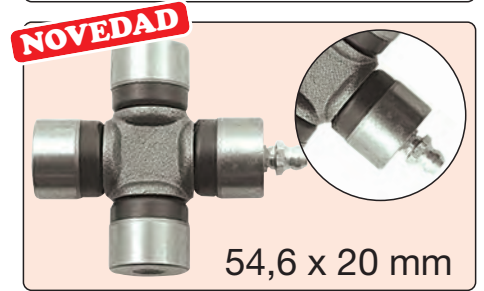

Ref.: 66-06-602
Ref. OE: 04371-87502 / 04371-87504

Ranger 2.5 TD
y 2.5 TD 4x4

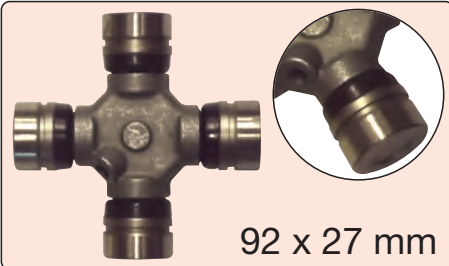

Ref.: 66-03-300
Ref. OE: FS05-18-400

Ranger 2.5 TDDI y
2.5 TDCI 4x4

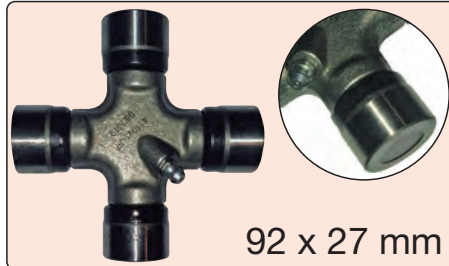

Ref.: 4746936
Ref. OE: 05014062AA / 1454602

Ranger 2.5 TDDI
(2005→)

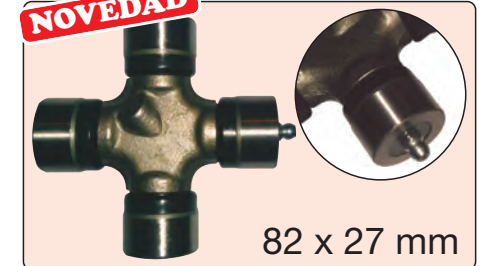

Ref.: 66-03-303
Ref. OE: 1454601 / SA67-25-06X

Civic I 1.5 4WD
Civic II 1.6 4WD

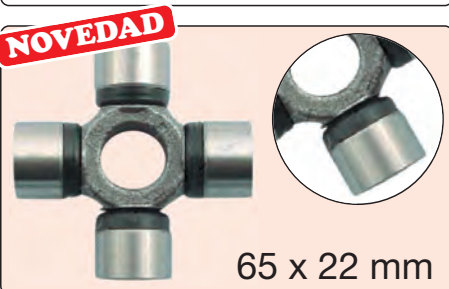

Ref.: 66-04-400
Ref. OE: 44330-538-004





HYUNDAI

ESTANFI
AUTOMOCION

Santa Fe (todos)
Galloper II (todos)

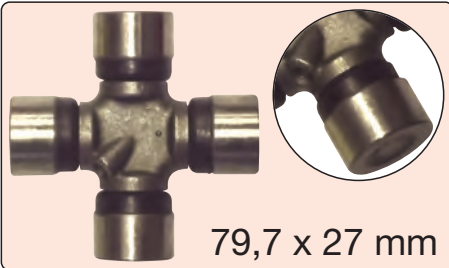

Ref.: 66-0H-H00
Ref. OE: 49140-43001 / 49140-4A000
/ SB000056

Galloper II (todos)
Terracan

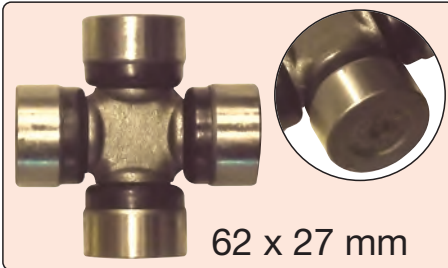

Ref.: 66-0H-H01
Ref. OE: S2000055A

H-1 Starex 2.4, 2.4
4WD, 2.5 TD y CRDI



Ref.: 66-0H-H04
Ref. OE: 491404A400 / 04371-87304

ISUZU

ESTANFI
AUTOMOCION

Campo

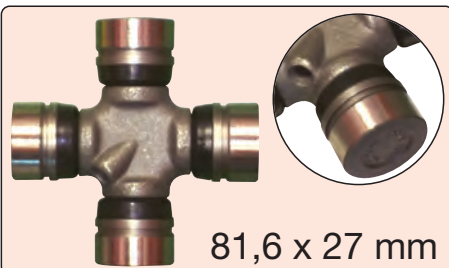

Ref.: 66-00-005
Ref. OE: 4723072

Campo 2.5 D
Pick-Up

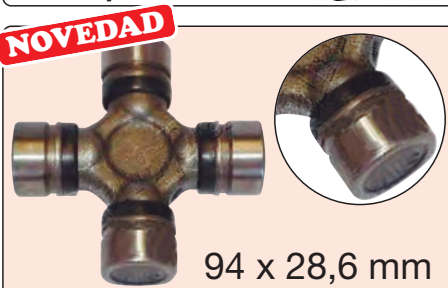

Ref.: 66-0W-W00
Ref. OE: 12479126

Campo
Trooper

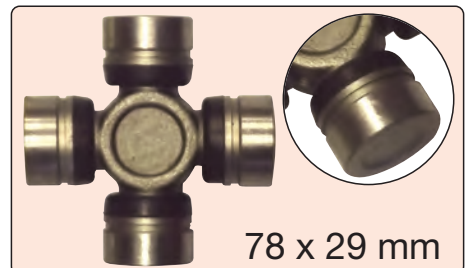

Ref.: 66-02-203
Ref. OE: 04371-30020 / 04371-30021
/ 04371-30030 / 04371-30040

Trooper (todos)

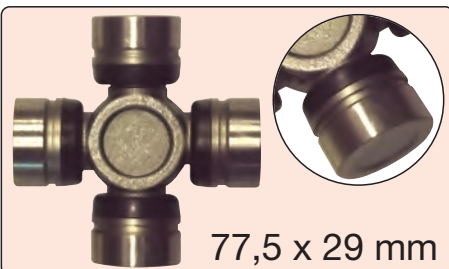

Ref.: 66-02-200
Ref. OE: 04371-35031 / 04371-35050

Trooper 3.5 V6 y
Fuoristrada 3.5 V6

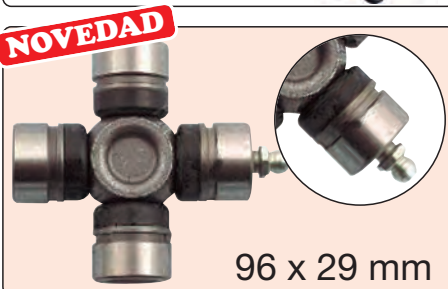

Ref.: 66-09-908
Ref. OE: 8-97167-317-0

D-Max

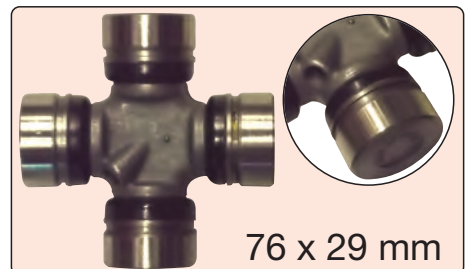

Ref.: 66-09-901
Ref. OE: 8979428460 / M3T30286



D-Max 

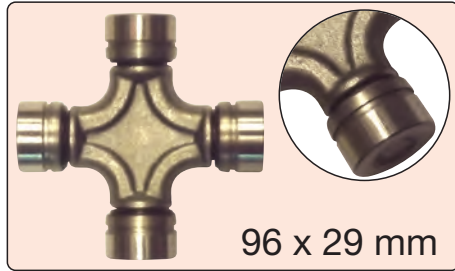

96 x 29 mm

Ref.: 66-09-902
Ref. OE: 8979430420

D-Max 2.5 D 

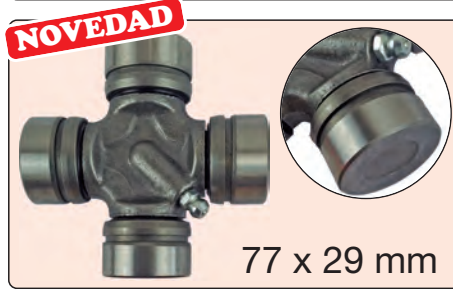

77 x 29 mm

Ref.: 66-09-912
Ref. OE: 8-97942845-0 / -1

Elf Pianale 4.6 DITD 
Trooper 2.2 D 4x4

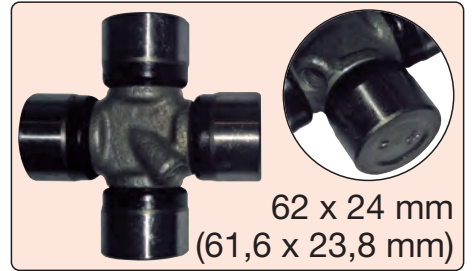

62 x 24 mm
(61,6 x 23,8 mm)

Ref.: 27200-85C00
Ref. OE: 00456010 / 00456019

Serie NKR69S, 
NPR69M, NPR69L

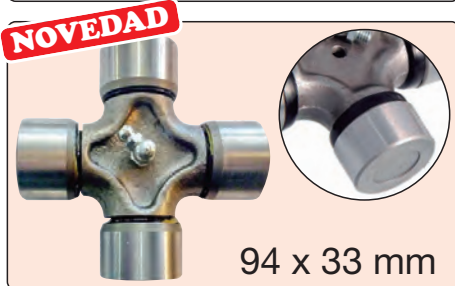

94 x 33 mm

Ref.: 66-09-906
Ref. OE: 8-97080-505-0 / -1

NPR 55 2.8, 65 4.0 D, 
69 3.0 D, 77 3.0 D

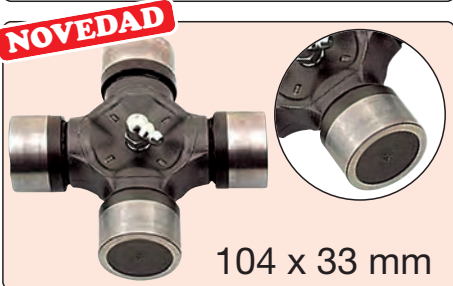

104 x 33 mm

Ref.: 66-09-907
Ref. OE: 8-97322-749-0 / -1

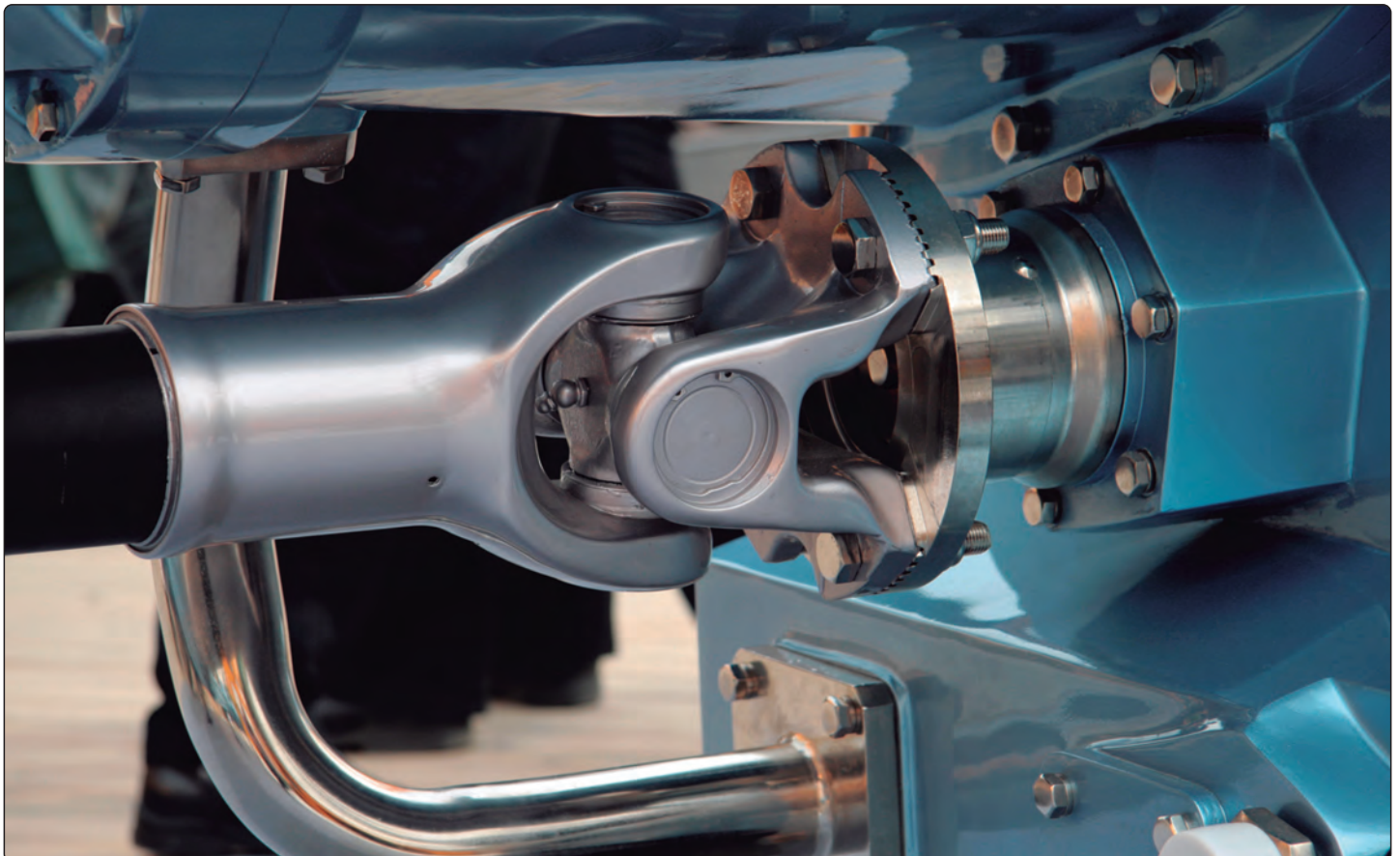

XJ / ZJ / TJ
JK / YJ GR

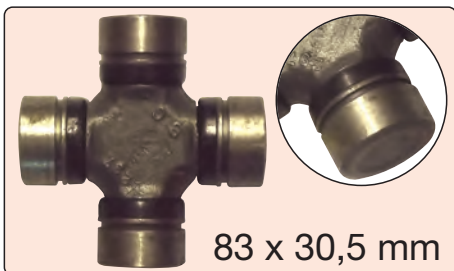

83 x 30,5 mm

Ref.: 8126638
Ref. OE: 8126638

XJ / ZJ / TJ
JK / YJ GR

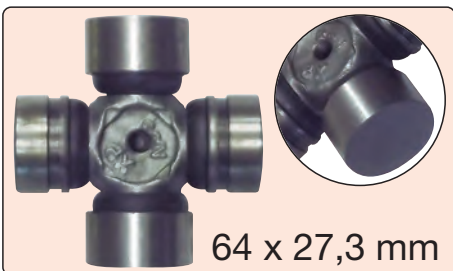

64 x 27,3 mm

Ref.: 8126610
Ref. OE: 8126610

SJ

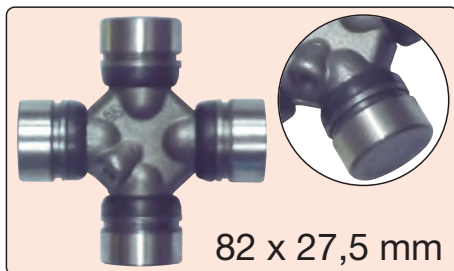

82 x 27,5 mm

Ref.: 8126636
Ref. OE: 8126636

Cherokee (1984→), Grand
Cherokee y Wrangler I

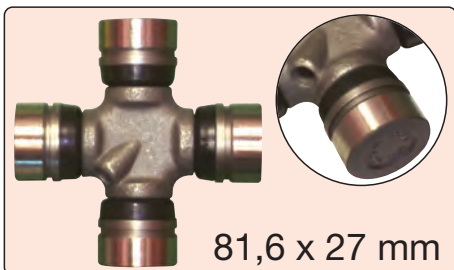

81,6 x 27 mm

Ref.: 66-00-005
Ref. OE: 4723072

Cherokee (1984→), Grand
Cherokee, Wrangler I y II

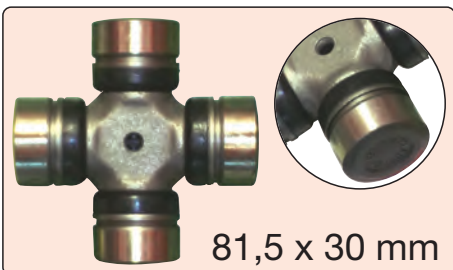

81,5 x 30 mm

Ref.: 66-00-006
Ref. OE: 8126638

Cherokee (1984→)
Grand Cherokee

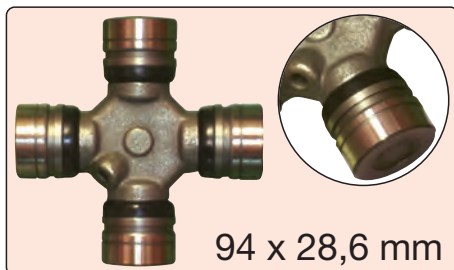

94 x 28,6 mm

Ref.: 66-00-007
Ref. OE: 4505575

Cherokee (2001), Grand
Cherokee y Wrangler I

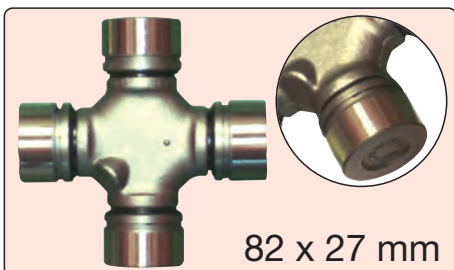

82 x 27 mm

Ref.: 66-00-098
Ref. OE: 9771333340

Cherokee (2001), Grand
Cherokee II y Wrangler II

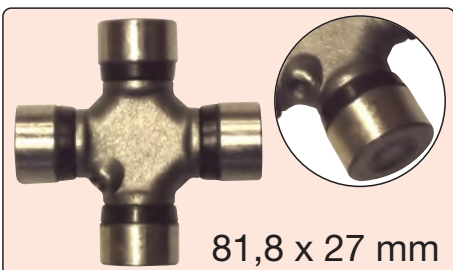

81,8 x 27 mm

Ref.: 66-00-099
Ref. OE: 8126614 / 8130750 / 4882793

Cherokee XJ

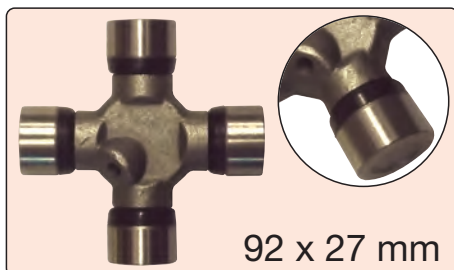

92 x 27 mm

Ref.: 66-01-108
Ref. OE: 37125-EB51A

Cherokee 2.5 CDR y
Grand Cherokee I 5.9 I

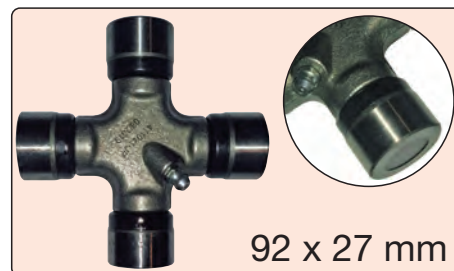

92 x 27 mm

Ref.: 4746936
Ref. OE: 05014062AA / 1454602

Willys

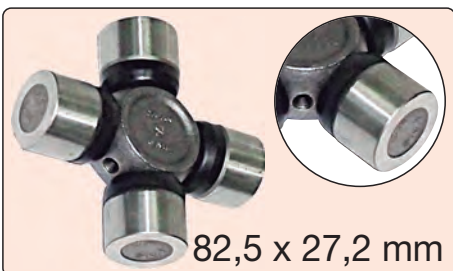

82,5 x 27,2 mm

Ref.: 8126614
Ref. OE: 8126614



**Sorento y
Sportage (todos)**

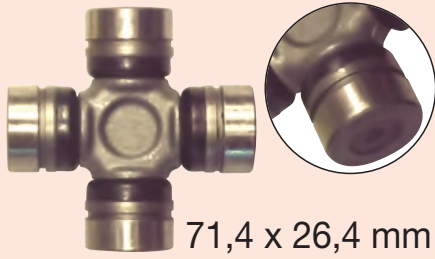

71,4 x 26,4 mm

Ref.: 66-0K-K00
Ref. OE: 0N01025060A

Sorento

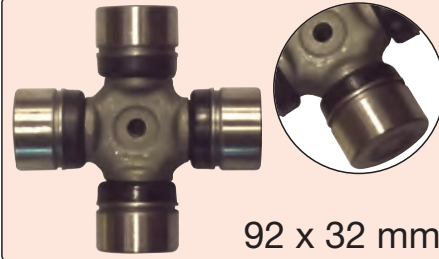

92 x 32 mm

Ref.: 66-0K-K01
Ref. OE: 0W001-25-060A /
/ HE41-99-152B



LAND ROVER y SANTANA

**Land Rover
Santana**

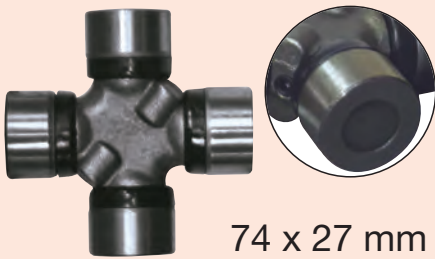

74 x 27 mm

Ref.: 242521
Ref. OE: 242521

**Land Rover
Santana**

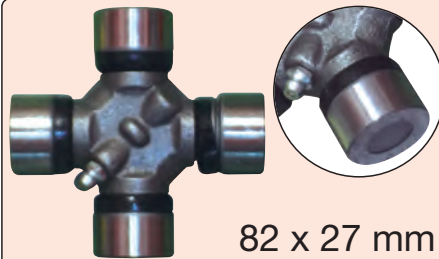

82 x 27 mm

Ref.: 541858
Ref. OE: 541858

**Santana 88
5 vel. 2500 DC**

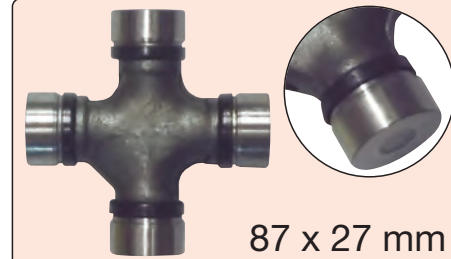

87 x 27 mm

Ref.: 193738
Ref. OE: 193738

**Santana 88
5 vel. 2500 DC**

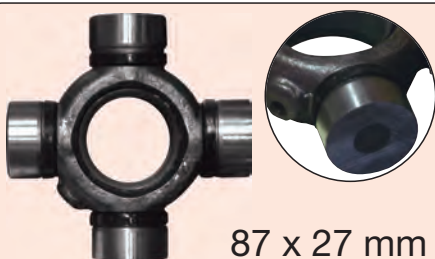

87 x 27 mm

Ref.: 193742
Ref. OE: 193742

Defender

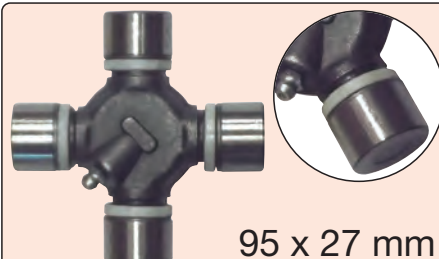

95 x 27 mm

Ref.: STC4807
Ref. OE: STC4807

Defender

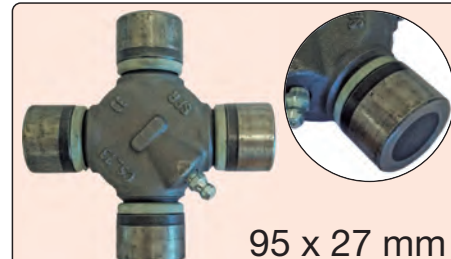

95 x 27 mm

Ref.: STC4807G
Ref. OE: STC4807 (original GKN)



Defender (2007→)

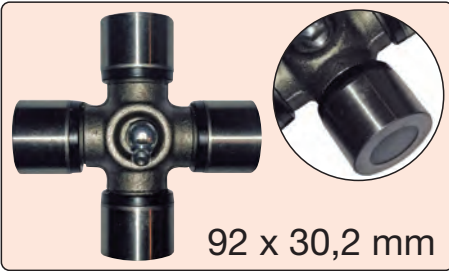

Ref.: TVC500010
Ref. OE: TVC500010

Defender y Discovery

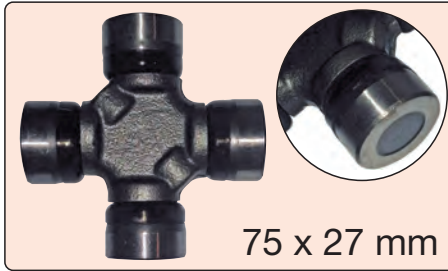

Ref.: RTC3458
Ref. OE: RTC345

Defender y Discovery

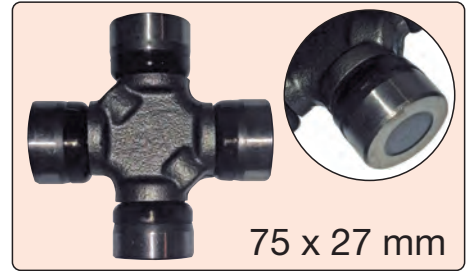

Ref.: RTC3458G
Ref. OE: RTC3458 (original GKN)

Freelander 1.8, 1.8 I, 2.0 DI, Soft Top 1.8

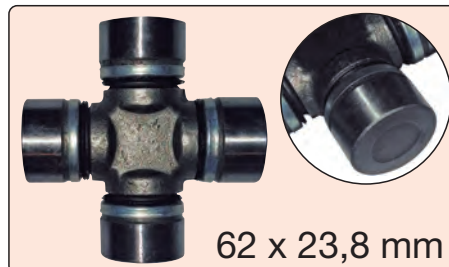

Ref.: TVF100000
Ref. OE: TVF100000

Range Rover Classic y Discovery

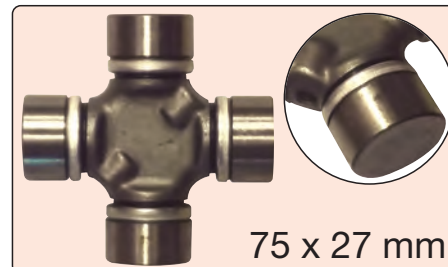

Ref.: RTC4587
Ref. OE: RTC4587 / 8126637

88", 109", 90, 110, Defender, Discovery, Range Rover

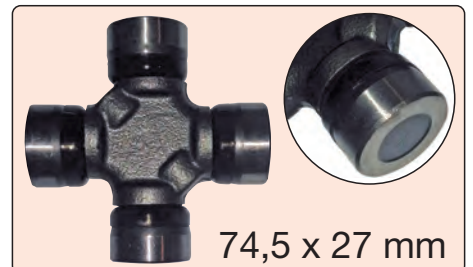

Ref.: RTC3458
Ref. OE: 2720086CT0 / TVC100010





MAZDA

ESTANFI
AUTOMOCION

Serie B



**Serie B 2.0, 2.2 D,
2.5 D, 2.6 y 2.6 4x4**



**Serie B 2.5 D, 2.6 TD, 2.6 y
BT-50 2.5 CD y 3.0 CDVI**

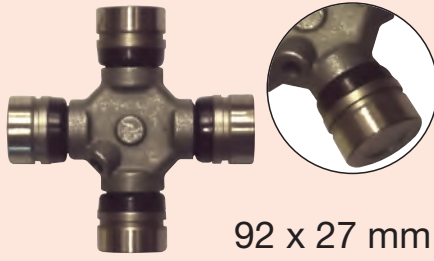

92 x 27 mm

Ref.: 66-03-300
Ref. OE: FS05-18-400

NOVEDAD



80 x 28 mm

Ref.: 66-03-305
Ref. OE: 0604-25-060 / 0604-89-251

NOVEDAD

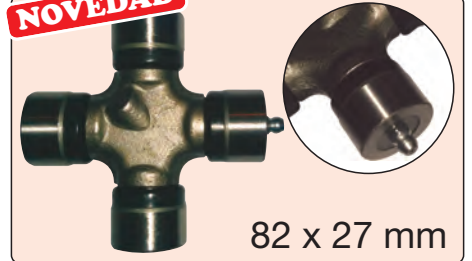

82 x 27 mm

Ref.: 66-03-303
Ref. OE: 1454601 / SA67-25-06X

**BT-50 2.5 CD 4WD y
3.0 CDVI 4x4 (2006→)**



**323 C, 323 III, 323 S,
626 III, RX 7 I**



**Mazda 6 (GG)
2.3 (2005→)**

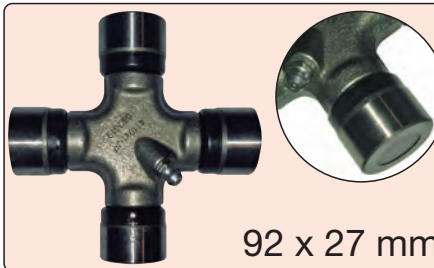

92 x 27 mm

Ref.: 4746936
Ref. OE: 05014062AA / 1454602

NOVEDAD



64 x 25 mm

Ref.: 66-03-304
Ref. OE: 0259-89-251 / 215825060

NOVEDAD



74 x 24 mm

Ref.: 66-03-301
Ref. OE: P00325060A



MITSUBISHI

ESTANFI
AUTOMOCION

**Montero I y II,
Sport y L200**



**Montero I, II y III,
Sport y L200**



**L200, Pajero Classic,
Montero I, II, III y IV e IO**

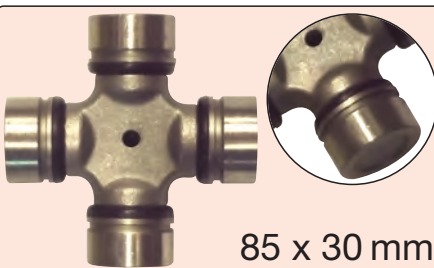

85 x 30 mm

Ref.: 66-05-502
**Ref. OE: MC834855 / MC994292 /
/ MR232151**

NOVEDAD



64 x 25 mm

Ref.: 27200-83812
Ref. OE: 27200-83812

NOVEDAD

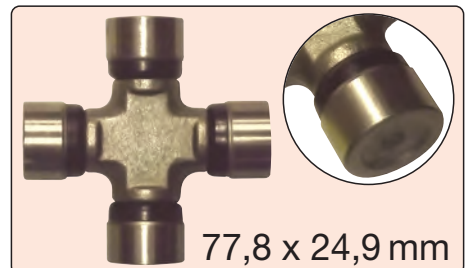

77,8 x 24,9 mm

Ref.: 66-05-501
**Ref. OE: MB000948 / MR196838
/ 8942522700**





MITSUBISHI

ESTANFI
AUTOMOCION

Pajero II

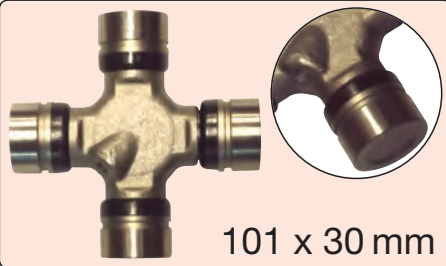

101 x 30 mm

Ref.: 66-05-503
Ref. OE: MR377128

**Galan IV 1.6 y 2.0,
Space Wagon 2.0**



NOVEDAD



64 x 25 mm

Ref.: 66-05-504
Ref. OE: MB154554

**Pajero II 1.8 GDI,
Pajero Pinin 1.8**



NOVEDAD



76 x 27 mm

Ref.: 66-05-505
Ref. OE: MR580197

Canter 3.9 TDI



NOVEDAD



102 x 31,7 mm

Ref.: 66-05-506
Ref. OE: MB293448 / MC834856



NISSAN

ESTANFI
AUTOMOCION

Cabstar 2.5 D



NOVEDAD



80,6 x 25 mm

Ref.: 66-01-111
Ref. OE: 37125-76000 / 37125-J2025

**Patrol GR I,
Pick-Up, Terrano I**

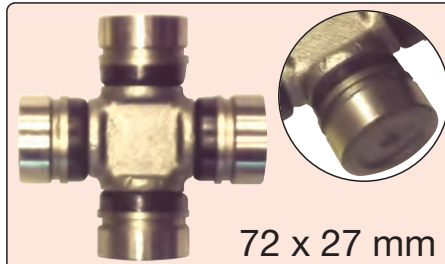

72 x 27 mm

Ref.: 66-01-101
Ref. OE: 37126-01G25/26
/ 37125-20J25

**Patrol GR I/II, Patrol K160/K260,
Pick Up, Pick Up (D22), Terrano I**

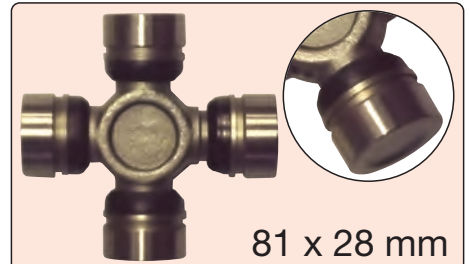

81 x 28 mm

Ref.: 66-01-102
Ref. OE: 37125-C9425 / 37126-C9425

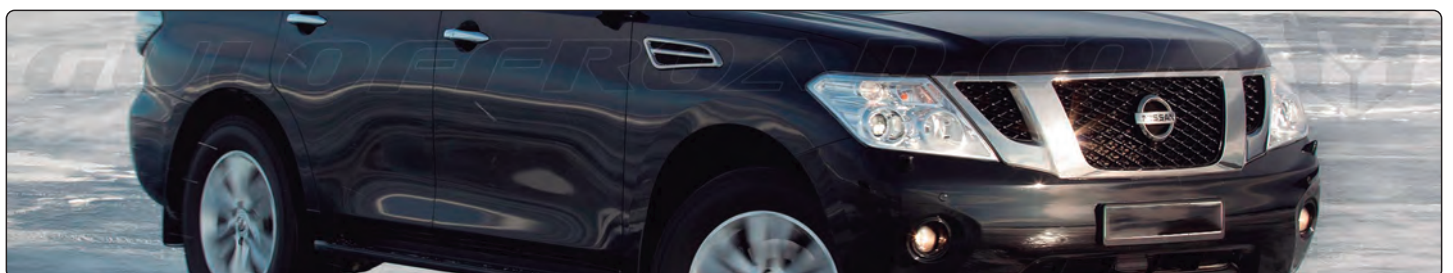



NISSAN

ESTANFI
AUTOMOCION

**Patrol GR I y II
Patrol K260**

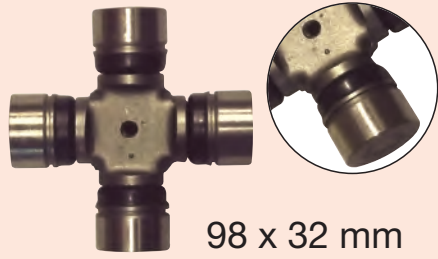

98 x 32 mm

Ref.: 66-01-104
Ref. OE: 37125-01J25

Terrano II 2.7

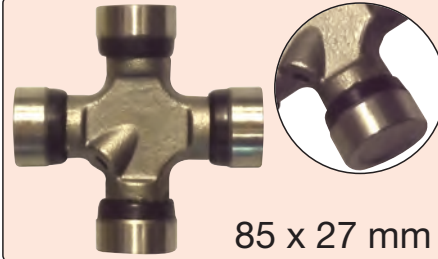

85 x 27 mm

Ref.: 66-01-105
Ref. OE: 37125-7F025

**Terrano II 2.7 TD y
TDI y 3.0 DI y DTD**

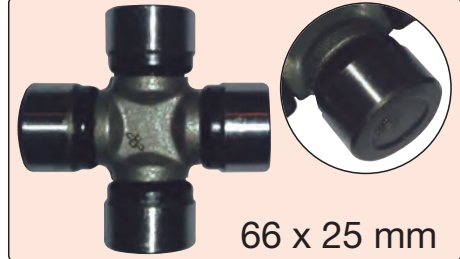

66 x 25 mm

Ref.: 66-01-110
Ref. OE: 37125-2X800 / 37125-2X825

**Navara y Pathfinder (2005→)
Terrano II 3.0 Di**

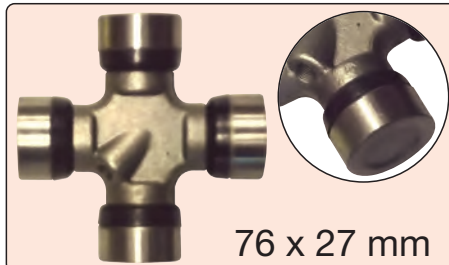

76 x 27 mm

Ref.: 66-01-107
Ref. OE: 37125-2X801 / 0K2AA32907

**Navara y
Pathfinder (2005→)**

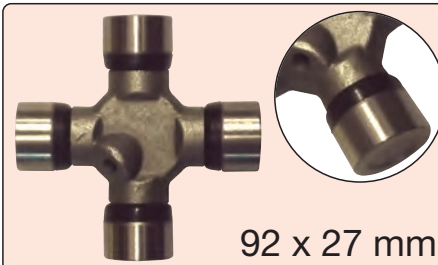

92 x 27 mm

Ref.: 66-01-108
Ref. OE: 37125-EB51A

**Navara y
Pathfinder**

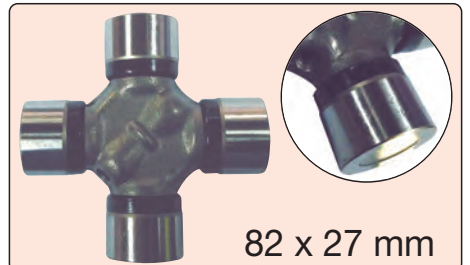

82 x 27 mm

Ref.: 66-01-109
Ref. OE: 37125-EB30A

**Pick-Up (D22),
Pick-Up, Terrano I**

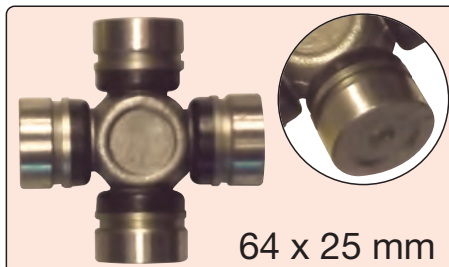

64 x 25 mm

Ref.: 66-08-801
Ref. OE: 27200-73813 / 37125-9W26
/ 37127-49W26 / 27125-79W26

Trade

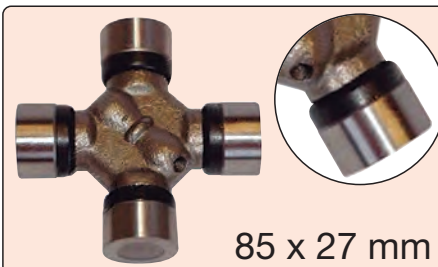

85 x 27 mm

Ref.: 66-01-103
Ref. OE: 39625-G9825

Trade

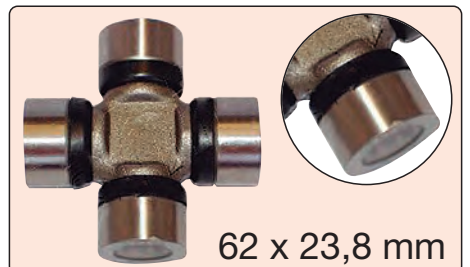

62 x 23,8 mm

Ref.: 66-01-106
Ref. OE: 016905308-0 / MD144816

**Trade
Furgonato 2.0 D**

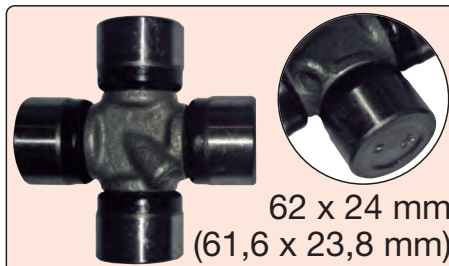

62 x 24 mm
(61,6 x 23,8 mm)

Ref.: 27200-85C00
Ref. OE: 00456010 / 00456019





OPEL

ESTANFI
AUTOMOCION

Campo 2.5 y 3.1
Monterey 3.1 y 3.2



NOVEDAD



77 x 29 mm

Ref.: 66-09-905

Ref. OE: 00454166 / 454166



SANTANA ANIBAL

ESTANFI
AUTOMOCION

Santana Aníbal

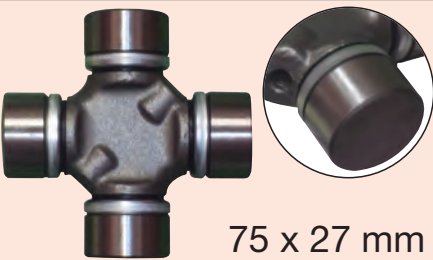

75 x 27 mm

Ref.: 27200-86CT0

Ref. OE: 27200-86CT0



SSANGYONG

ESTANFI
AUTOMOCION

Korando 2.2 D

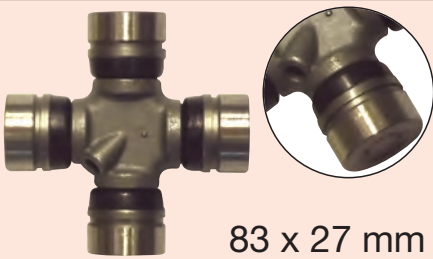

83 x 27 mm

Ref.: EST1046001

Ref. OE: 33115-01000

Korando 2.2 D

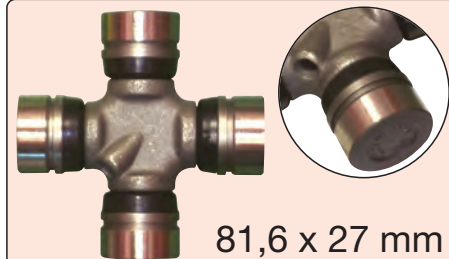

81,6 x 27 mm

Ref.: 66-00-005

Ref. OE: 4723072

Korando 2.3 D/2.9 D
TD-Musso

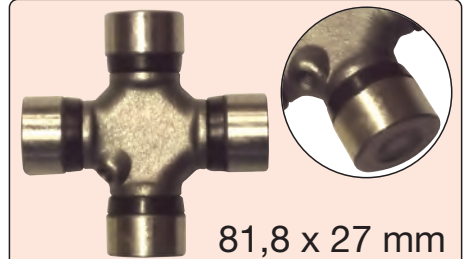

81,8 x 27 mm

Ref.: 66-00-099

Ref. OE: 8126614 / 8130750 / 4882793

Samurai 1.0 

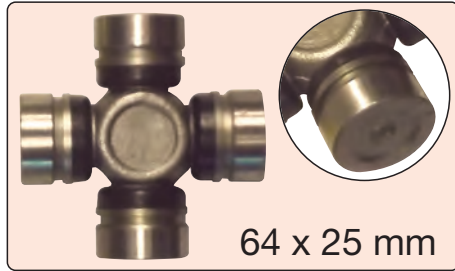

64 x 25 mm

Ref.: 66-08-801
Ref. OE: 27200-73813 / 37125-9W26 / 37127-49W26 / 27125-79W26

Samurai 1.3, 1.9 TD, Siderick 1.6 I, Vitara 1.6, 1.9 y Cabrio

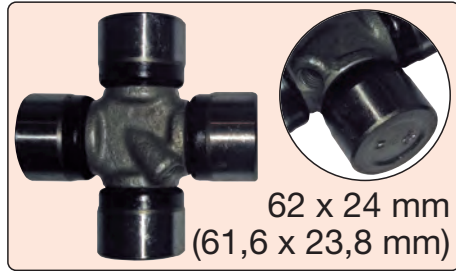

62 x 24 mm
(61,6 x 23,8 mm)

Ref.: 27200-85C00
Ref. OE: 00456010 / 00456019

Samurai 1.3, 1.9 TD, Siderick 1.6 I, Vitara 1.6, 1.9 y Cabrio

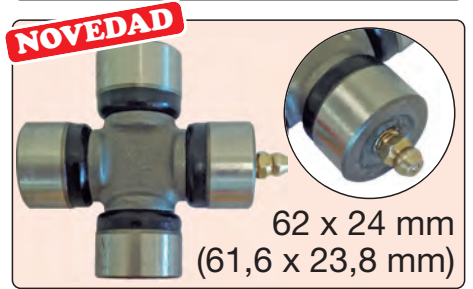

62 x 24 mm
(61,6 x 23,8 mm)

Ref.: 27200-85C00/E
Ref. OE: 00456010 / 00456019

Grand Vitara 

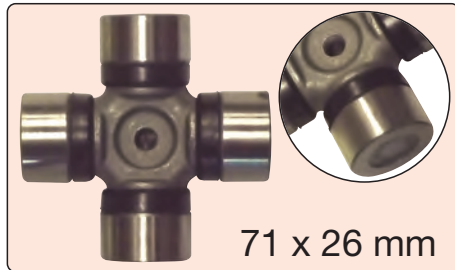

71 x 26 mm

Ref.: 66-08-803
Ref. OE: 27200-53830

Grand Vitara I, Jimny, Samurai, SJ410, SJ413, Vitara, X-90

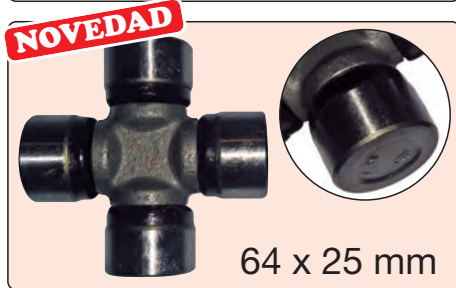

64 x 25 mm

Ref.: 66-08-805
Ref. OE: 27200-83812 / 27200-60810

Grand Vitara (2005→) 

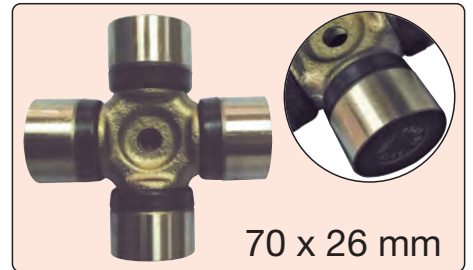

70 x 26 mm

Ref.: 66-08-802
Ref. OE: 27200-66810

Carry Furgonato 0.8 

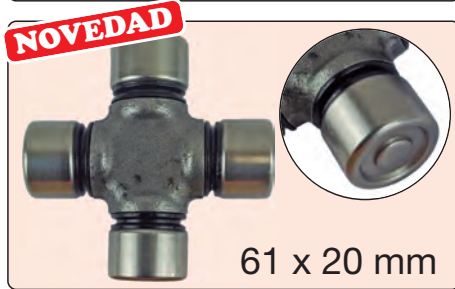

61 x 20 mm

Ref.: 66-08-804
Ref. OE: 27100-72100 / 27200-60511

Super Carry Autobus 1.0 

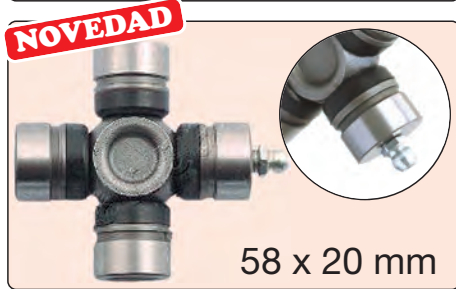

58 x 20 mm

Ref.: 66-08-806
Ref. OE: 27100-6700



4 Runner (87→96), Hi-Lux (84→06),
Land Cruiser J12, J7, J100, J8, J9

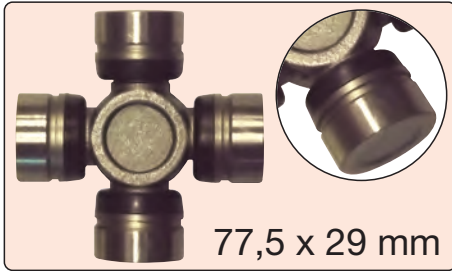

Ref.: 66-02-200
Ref. OE: 04371-35031 / 04371-35050

Hilux (84→06)

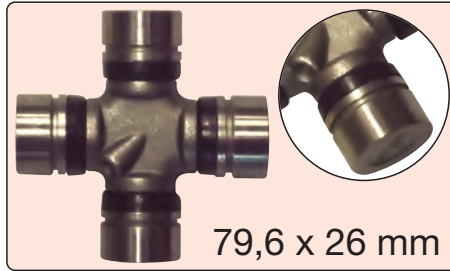

Ref.: 66-02-201
Ref. OE: 04371-25010

Hilux III Pick-Up
2.5 D 4x4 (2005→)



NOVEDAD

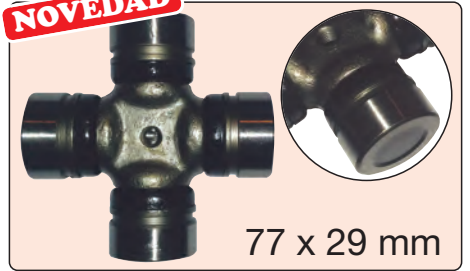

Ref.: 66-02-205
Ref. OE: 04371-0K060 / 043710K050

Hilux III 2.5 D y 3.0 D
Hiace 2.5 D4D (2006→)



NOVEDAD

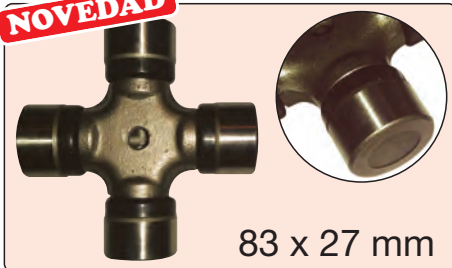

Ref.: 66-02-207
Ref. OE: 04371-04010 / 04375-0K010

Land Cruiser

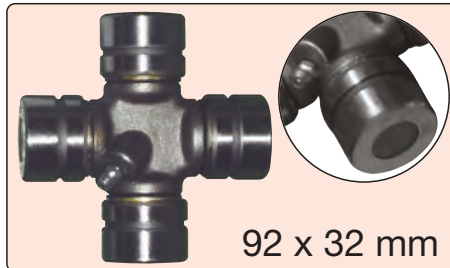

Ref.: 04371-36021
Ref. OE: 04371-36021

Land Cruiser
J4 (69→86), J7, J8

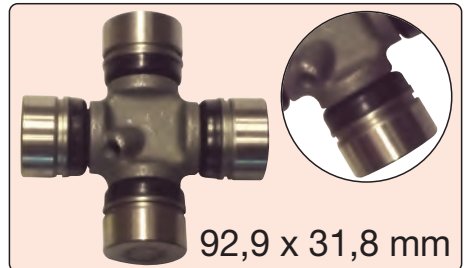

Ref.: 66-02-202
Ref. OE: 04371-35040 / 04371-36020

Land Cruiser, 4 Runner, Camry,
Celica, Hiace, Hilux, Supra

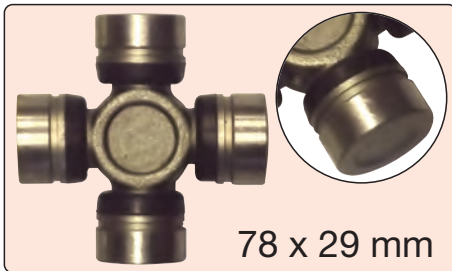

Ref.: 66-02-203
Ref. OE: 04371-30020 / 04371-30021
/ 04371-30030 / 04371-30040
/ 04371-30041 / 31111-2205

Land Cruiser J6 4.0
Corolla, Starlet

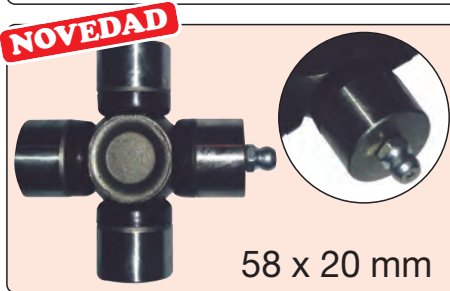

Ref.: 66-02-204
Ref. OE: 04371-10010 / 37411-10010

Land Cruiser 90 2.7 y
Modell F Autobus



NOVEDAD

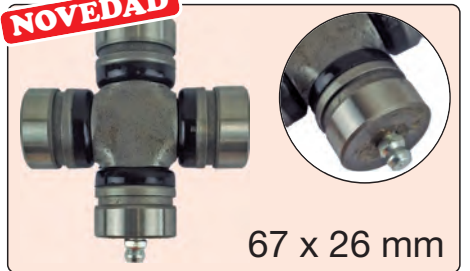

Ref.: 66-02-209
Ref. OE: 04371-20010 / 04371-22010

Dyna 4.0 D4D (2006→)



Ref.: 66-02-206
Ref. OE: 04371-37080

Dyna 250 / 400
4.6 TDI y D4D (2003→)



NOVEDAD



Ref.: 66-02-208
Ref. OE: 04371-37011 / 0437137020



Safari



Safari Safari 1.9 D,
2.0 (16V), 2.0 TD 4x4

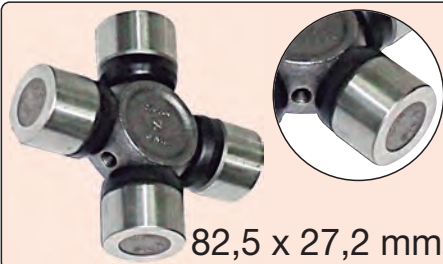

82,5 x 27,2 mm

Ref.: 8126614
Ref. OE: 8126614

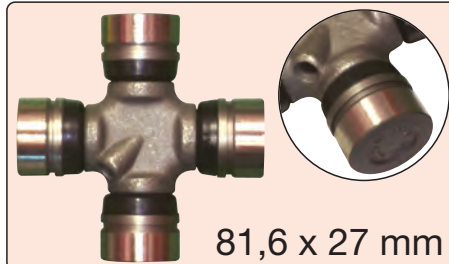

81,6 x 27 mm

Ref.: 66-00-005
Ref. OE: 4723072



VAUXHALL

Brava Pick-Up
2.5 TD y 2.5 TD 4x4



NOVEDAD

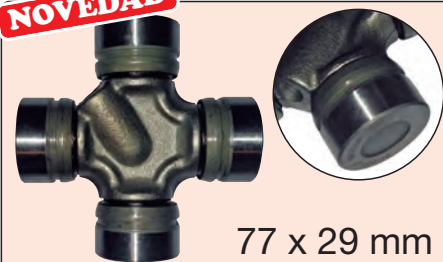

77 x 29 mm

Ref.: 66-09-905
Ref. OE: 00454166 / 454166



TRÍPODES HOMOCINÉTICA

Completo stock, formado por más de 65 referencias.
Las aplicaciones más comunes son Ford, Volkswagen, Seat y Audi.

13-992600



Para Ford Transit

13-992600



Para VW, Seat y Audi



Listado por marcas

DAIHATSU

- Rocky, Feroza, Taft Ref.: **66-06-600**
- Feroza Ref.: **66-06-601**
- Hijet Furgonato, Hijet Pick-Up 1.0 Ref.: **66-06-602**

FORD

- Ranger 2.5 TD y 2.5 TD 4x4 Ref.: **66-03-300**
- Ranger 2.5 TDDI y 2.5 TDCI 4x4 Ref.: **4746936**
- Ranger 2.5 TDDI (2005→) Ref.: **66-03-303**

HONDA

- Civic I 15 4WD, Civic II 1.6 4WD Ref.: **66-04-400**

HYUNDAI

- Santa Fé (todos), Galloper II (todos) Ref.: **66-0H-H00**
- Galloper II (todos), Terracan Ref.: **66-0H-H01**
- H-1 Starex 2.4, 2.4 4WD, 2.5 TD y CRDI Ref.: **66-0H-H04**

ISUZU

- Campo Ref.: **66-00-005**
- Campo 2.5 D Pick-Up Ref.: **66-0W-W00**
- Campo, Trooper Ref.: **66-02-203**
- Trooper (todos) Ref.: **66-02-200**
- Trooper 3.5 V6 y Fuoristrada 3.5 V6 Ref.: **66-09-908**
- D-Max Ref.: **66-09-901**
- D-Max Ref.: **66-09-902**
- D-Max 2.5 D Ref.: **66-09-912**
- Elf Pianale 4.6 DITD, Trooper 2.2 D 4x4 Ref.: **27200-85C00**
- Serie NKR69S, NPR69M, NPR69L Ref.: **66-09-906**
- NPR55 2.8, 65 4.0 D, 69 3.0 D, 77 3.0 D Ref.: **66-09-907**

JEEP

- XJ / ZJ / TJ / JK / YJ GR Ref.: **8126638**
- XJ / ZJ / TJ / JK / YJ GR Ref.: **8126610**
- SJ Ref.: **8126636**
- Cherokee (1984→), Grand Cherokee, Wrangler I Ref.: **66-00-005**
- Cherokee (1984→), Grand Cherokee, Wrangler I y II Ref.: **66-00-006**
- Cherokee (1984→), Grand Cherokee Ref.: **66-00-007**
- Cherokee (2001), Grand Cherokee, Wrangler I Ref.: **66-00-098**
- Cherokee (2001), Grand Cherokee II, Wrangler II Ref.: **66-00-099**
- Cherokee XJ Ref.: **66-01-108**
- Cherokee 2.5 CDR y Grand Cherokee I 5-9 I Ref.: **4746936**
- Willys Ref.: **8126614**

KIA

- Sorento y Sportage (todos) Ref.: **66-0K-K00**
- Sorento Ref.: **66-0K-K01**

LAND ROVER Y SANTANA

- Santana Ref.: **242521**
- Santana Ref.: **541858**
- Santana 88 5 velocidades / 2.500 DC Ref.: **193738**
- Santana 88 5 velocidades / 2.500 DC Ref.: **193742**
- Defender Ref.: **STC4807**
- Defender Ref.: **STC4807G**
- Defender (2007→) Ref.: **TVC500010**
- Defender y Discovery Ref.: **RTC3458**
- Defender y Discovery Ref.: **RTC3458G**
- Freelander 1.8, 1.8 I, 2.0 DI, Soft Top 1.8 Ref.: **TVF100000**
- Range Rover Classic y Discovery Ref.: **RTC4587**
- 88", 109", 90, 110, Defender, Discovery y Range Rover Ref.: **RTC3458**

MAZDA

- Serie B Ref.: **66-03-300**
- Serie B 2.0, 2.2 D, 2.5 D, 2.6, 2.6 4x4 Ref.: **66-03-305**
- Serie B 2.5 D, 2.6, 2.6 TD y BT-50 2.5 CD, 3.0 CDVI Ref.: **66-03-303**
- BT-50 2.5 CD 4WD y 3.0 CDVI 4x4 Ref.: **4746936**
- 323 C, 323 III, 323 S, 626 III, RX 7 I Ref.: **66-03-304**
- Mazda 6 (GG) 2.3 (2005→) Ref.: **66-03-301**

MITSUBISHI

- Montero I, II. Sport y L200 Ref.: **66-05-502**
- Montero I, II y III, Sport y L200 Ref.: **27200-83812**
- L200, Pajero Classic, Montero I, II, III y IV e IO Ref.: **66-05-501**
- Pajero II Ref.: **66-05-503**
- Pajero II 1.8 GDI, Pajero Pinin 1.8 Ref.: **66-05-505**
- Galan IV 01.6 y 2.0, Space Wagon 2.0 Ref.: **66-05-504**
- Canter 3.9 TDI Ref.: **66-05-506**

NISSAN

- Cabstar 2.5 D Ref.: **66-01-111**
- Patrol GR I, Pick Up, Terrano I Ref.: **66-01-101**
- Patrol GR I y II, Patrol K160 y K260, Pick Up, Pick Up (D22), Terrano I Ref.: **66-01-102**
- Patrol GR I y II, Patrol K260 Ref.: **66-01-104**
- Terrano II 2.7 Ref.: **66-01-105**
- Terrano II 2.7 TD y TDI, 3.0 DI y DITD Ref.: **66-01-110**
- Navara, Pathfinder (2005 →), Terrano II 3.0 Di Ref.: **66-01-107**
- Navara y Pathfinder (2005→) Ref.: **66-01-108**
- Navara y Pathfinder Ref.: **66-01-109**
- Pick Up, Pick Up (D22), Terrano I Ref.: **66-08-801**
- Trade Ref.: **66-01-103**
- Trade Ref.: **66-01-106**
- Trade Furgonato 2.0 D Ref.: **27200-85C00**

OPEL

- Campo 2.5, 3.1 y Monterey 3.1, 3.2 Ref.: **66-09-908**

SANTANA

- Aníbal Ref.: **27200-86CT0**

SSANGYONG

- Korando 2.2 D Ref.: **EST1046001**
- Korando 2.2 D Ref.: **66-00-005**
- Korando 2.3 D, 2.9 D y TD - Musso Ref.: **66-00-099**

SUZUKI

- Samurai 1.0 Ref.: **66-08-801**
- Samurai 1,3, 1.9 TD, Siderick 1.6 I, Vitara 1.6, 1.9 y Cabrio Ref.: **27200-85C00**
- Grand Vitara Ref.: **66-08-803**
- Grand Vitara I, Jimny, Samurai, SJ10, SJ413, Vitara, X-90 Ref.: **66-08-805**
- Grand Vitara (2005 →) Ref.: **66-08-802**
- Carry Furgonato 0.8 Ref.: **66-08-804**
- Super Carry Autobus 1.0 Ref.: **66-08-806**

TATA

- Safari Ref.: **8126614**
- Safari 1.9 D, 2.0 (16V), 2.0 TD 4x4 Ref.: **66-00-005**

TOYOTA

- 4 Runner (87→96), Hilux (84→06) Land Cruiser J12, J7, J100, J8, J9 Ref.: **66-02-200**
- Hilux (84→06) Ref.: **66-02-201**
- Hilux III Pick-Up 2.5 D 4x4 (2005→) Ref.: **66-02-205**
- Hilux III 2.5 D y 3.0 D Ref.: **66-02-207**
- Hiace 2.5 D4D (2006→) Ref.: **04371-36021**
- Land Cruiser Ref.: **66-02-202**
- Land Cruiser J4 (69→86), J7, J8 Ref.: **66-02-202**
- Land Cruiser, 4 Runner, Camry, Celica, Hiace, Hilux, Supra Ref.: **66-02-203**
- Land Cruiser J6 4.0, Corolla, Starlet Ref.: **66-02-204**
- Land Cruiser 90 2.7 y Modell F Autobus Ref.: **66-02-209**
- Dyna 4.0 D4D (2006→) Ref.: **66-02-206**
- Dyna 250 / 400, 4.6 TDI y D4D (2003→) Ref.: **66-02-208**

VAUXHALL

- Brava Pick-Up 2.5 TD y 2.5 TD 4x4 Ref.: **66-09-905**

CAMIONES EUROPEOS

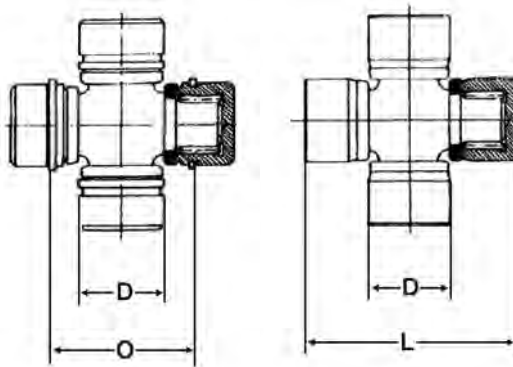

D = Ø Diámetro del rodamiento
O = Anillo interior
L = Anillo exterior

Referencia	Descripción	Ref. Original	D	O	L
CDT-20-001	Cruceta	385 410 02 31	38,05	62,00	
CDT-20-002	Cruceta	385 410 01 31	42	72,00	
CDT-20-003	Cruceta	304 410 00 31	45,04		120,4
CDT-20-004	Cruceta	385 410 05 31	48		126
CDT-20-005	Cruceta	335 410 00 31	52,03		133
CDT-20-006	Cruceta	363 410 03 31	53		135
CDT-20-007	Cruceta	387 410 00 31	57		152
CDT-20-008	Cruceta	656 410 01 31	68,04	95,20	166

Daimler-Benz



Volvo



CDT-20-018	Cruceta	232458		44	126,2
CDT-20-009	Cruceta	232459 Volvo N10/1651032 (Con arandelas y tornillos)		50	15,6
CDT-20-010	Cruceta	232540		57	144
CDT-20-011	Cruceta	1651229 Volvo F12 (Con arandelas y tornillos)		57	152,6



CAMIONES EUROPEOS

Referencia	Descripción	Ref. Original	D	O	L
Scania 					
CDT-20-012	Cruceta	29438	38		148
CDT-20-013	Cruceta	264043	44		149
CDT-20-014	Cruceta	0365901 - SCT 6901A / 294383 / 337059	48		161
CDT-20-015	Cruceta	264044	50		164
CDT-20-016	Cruceta	0366437 - STC 6902A / 366446 / 390225	57		164

Iveco 

Referencia	Descripción	Ref. Original	D	O	L
CDT-20-017	Cruceta	5017200	65		172

MAQUINARIA OBRA PUBLICA

Referencia	Descripción	Modelo	Número MFG
CDT-30-001	Cruceta Komatsu	D20-A3	101-10-17100 / 101-10-00070
CDT-30-002	Cruceta Komatsu	D20-A3	101-10-17200 / 101-10-00080
CDT-30-003	Cruceta Komatsu	D20-A3	101-10-00042 ASSY
CDT-30-004	Cruceta Komatsu	D30-APD31	111-10-16110 / 111-10-16120 / 113-12-00010
CDT-30-005	Cruceta Komatsu	D40.45 / D50 (35002-UP)	131-10-46110
CDT-30-006	Cruceta Komatsu	D50 (65001-UP)	135-14-00030
		D60-A6 (20006-UP)	145-14-00190
		D57S (6501-UP)	145-14-35110
CDT-30-007	Cruceta Komatsu	D80A-12D85	150-11-12360
CDT-30-008	Cruceta Komatsu	D150, 155	175-20-00060
CDT-30-009	Cruceta Komatsu	D60-A3	141-10-14210X1 SPIDER
			141-10-14160X2 BEARING
			141-10-14190X2 BEARING
CDT-30-010	Cruceta Komatsu	D60-A3	141-10-00012 W/YOKE ASSY
CDT-30-011	Cruceta Komatsu	D80.85	150-111-00097 W/YOKE ASSY
CDT-30-012	Cruceta Komatsu	D30	111-60-11110 FOR PUMP
CDT-30-013	Cruceta Komatsu	D80	154-66-12100 FOR WINCH

MAQUINARIA OBRA PUBLICA

Referencia	Descripción	Modelo	Número MFG
CDT-30-014	Cruceta Komatsu	500 507 510	380-135764-1
CDT-30-015	Cruceta Komatsu	JH90E JH80B	380-136142-1
CDT-30-016	Cruceta Komatsu	JH60A	380-154073-1 / 380-885518-1 / 380-886527-1 / 380-88651-1 /
CDT-30-017	Cruceta Komatsu	JH30 JH63	380-885526-1 380-885526-1 / 380-886765-1
CDT-30-018	Cruceta Komatsu	JH63 JH80B	380-890373-1 381-881908-1
CDT-30-019	Cruceta Komatsu	515	381-881908-1
CDT-30-020	Cruceta Komatsu	JH65	381-972625-1 / 381-976220-1
CDT-30-021	Cruceta Komatsu	JH90E	381-976907-1
CDT-30-022	Cruceta Komatsu	JH65	381-976908.1
CDT-30-023	Cruceta Komatsu	JH65	381-985204-1
CDT-30-024	Cruceta Komatsu	505 507	385-10155511
CDT-30-025	Cruceta Komatsu		385-10178551 / 385-10178561
CDT-30-026	Cruceta Komatsu	JH63 530	385-10178571
CDT-30-027	Cruceta Komatsu	540	385-10193741
CDT-30-028	Cruceta Komatsu	540	382-10238601
CDT-30-029	Cruceta Komatsu	540	419-20-12621 6CB2XR2

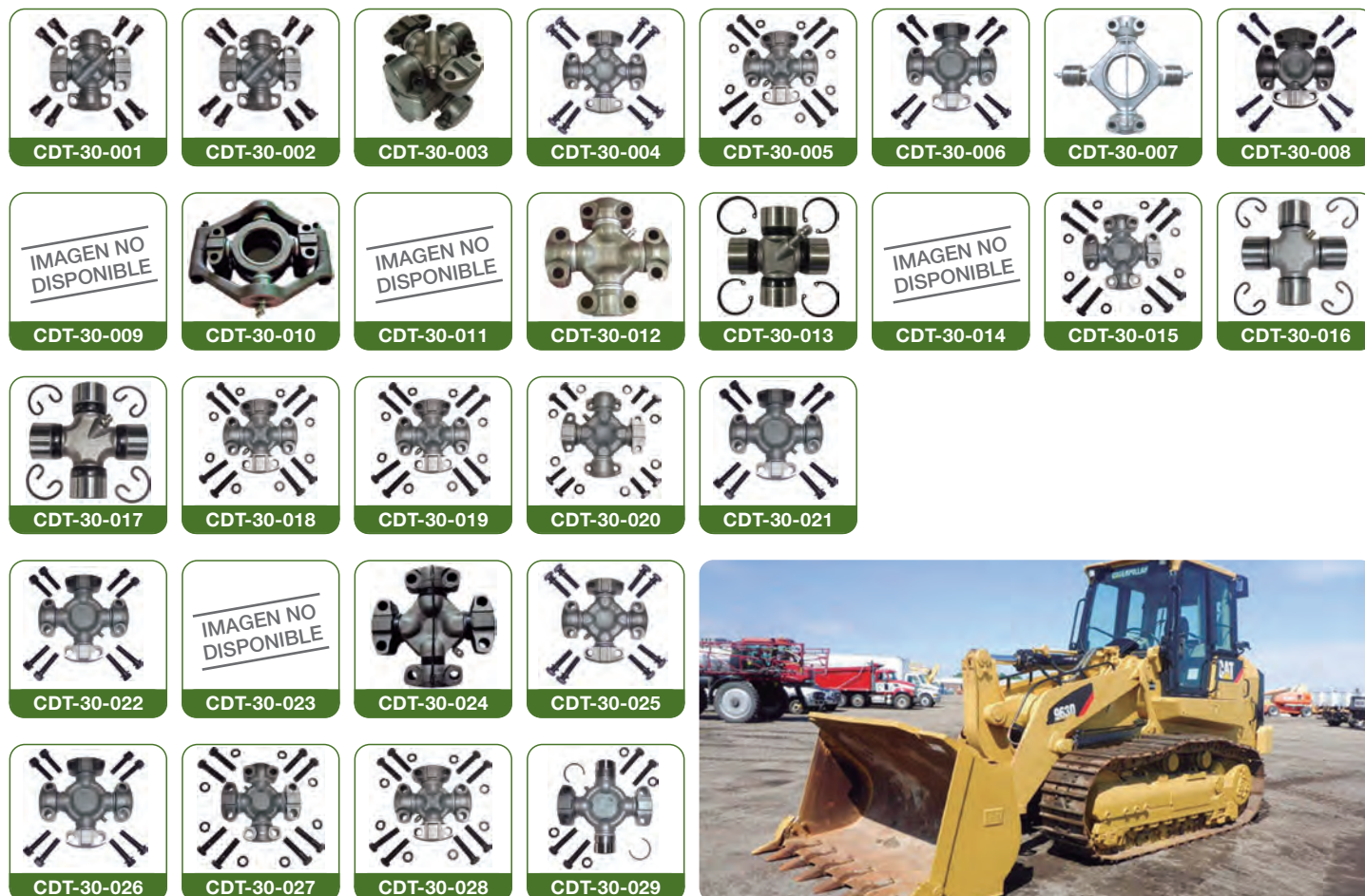

MAQUINARIA OBRA PUBLICA

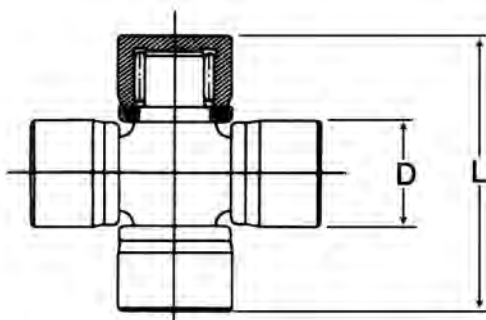

D = Ø Diámetro del rodamiento
L = Anillo exterior

Referencia	Descripción	D (mm)	L (mm)
CDT-40-001	Cruceta	18,0	47,0
CDT-40-002	Cruceta	19,0	52,0
CDT-40-003	Cruceta	22,0	54,0
CDT-40-004	Cruceta	22,0	54,7
CDT-40-005	Cruceta	23,8	61,3
CDT-40-006	Cruceta	25,0	72,1
CDT-40-007	Cruceta	27,0	70,0
CDT-40-008	Cruceta	27,0	74,3
CDT-40-009	Cruceta	29,0	80,0
CDT-40-010	Cruceta	30,0	82,1
CDT-40-011	Cruceta	30,2	80,0
CDT-40-012	Cruceta	30,2	92,0
CDT-40-013	Cruceta	30,2	106,5
CDT-40-014	Cruceta	32,0	75,9
CDT-40-015	Cruceta	34,0	90,2
CDT-40-016	Cruceta	34,0	106,5
CDT-40-017	Cruceta	34,9	106,4
CDT-40-018	Cruceta	39,7	116,0
CDT-40-019	Cruceta	34,9	106,5
CDT-40-020	Cruceta	36,0	89,0

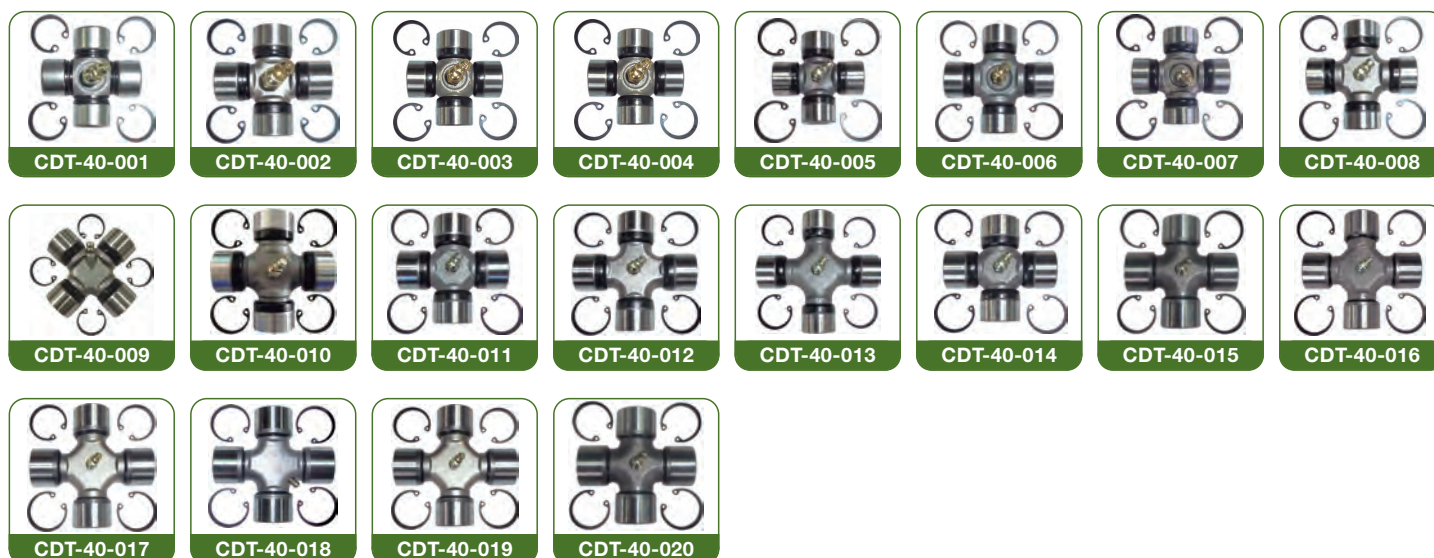

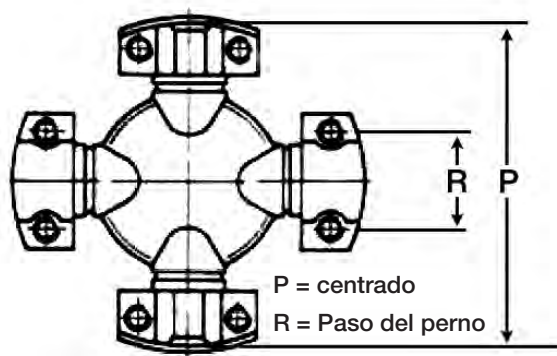
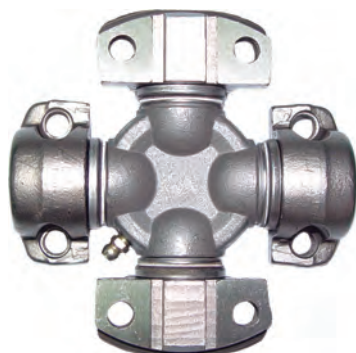
MAQUINARIA OBRA PUBLICA

Referencia	Descripción	R	P	Spicer	Precision	GKN	Alloy	Caterpillar
CDT-30-031	Cruceta	33,34	79	5-2002X	951	HS520		1250
CDT-40-022	Cruceta	33,34	79	5-2117X	994	HS521		316117
CDT-40-023	Cruceta	33,34	79	5-2116X	952	HS522	1063	6S6902
CDT-40-024	Cruceta	36,5	90,4	5-3000X	536	HS530	1711	5D9153
CDT-40-025	Cruceta	36,5	90,4	5-3014X	535	HS532		9K1976
CDT-40-026	Cruceta	36,5	90,4		966	HS533		
CDT-40-027	Cruceta	36,5	108	5-4002X	540	HS540	1703	6F7160
CDT-40-028	Cruceta	36,5	108	5-4143X	969	HS545	1689	6K0316
CDT-40-029	Cruceta	36,5	108	5-4123X	541	HS542	1704	6H1262
CDT-40-030	Cruceta	36,5	108	5-4140X	929	HS543	J4130	5M0800
CDT-40-031	Cruceta	42,88	115,06	5-5000X	550	HS550	1720	7J5251
CDT-40-032	Cruceta	42,88	115,06	5-5177X	968	HS555	1728	2K3631
CDT-40-033	Cruceta	42,88	115,06	5-5121X	552	HS552	1721	7J5245
CDT-40-034	Cruceta	42,88	115,06	5-5173X	933	HS553	1722	
CDT-40-035	Cruceta	49,20	134,8	5-5802X	896		1877	9C0398
CDT-40-036	Cruceta	42,88	140,45	5-6000X	560	HS560	1820	
CDT-40-037	Cruceta	42,88	140,45	5-6106X	905	HS565	1826	1S9670
CDT-40-038	Cruceta	42,88	140,45	5-6102X	563	HS563	1822	
CDT-40-039	Cruceta	42,88 49,22	140,45 148,38	5-6108X	568		1828	
CDT-40-040	Cruceta	42,88 49,22	140,45 148,38	5-6109X	569		1829	
CDT-40-041	Cruceta	42,88 49,22	140,45 148,38		493			
CDT-40-042	Cruceta	49,20	148,40	5-7000X	570	HS570	1841	8F7719
CDT-40-043	Cruceta	49,20	148,40	5-7150X	927	HS576	1840	2H0858
CDT-40-044	Cruceta	49,20	148,40	5-7202X	574	HS573	1843	7J5242
CDT-40-045	Cruceta	71,44	165	5-8500X	785	HS680		7K0442
CDT-40-046	Cruceta	71,44	165	5-8516X	963	HS685		2V7153
CDT-40-047	Cruceta	71,44	165		950	HS683		
CDT-40-048	Cruceta	49,20	206,31	5-8200X	581	HS580	1851	XX7146

MAQUINARIA OBRA PUBLICA

Referencia	Descripción	R	P	Spicer	Precision	GKN	Alloy	Caterpillar
CDT-40-049	Cruceta	49,2	206,31	5-8203X	584	HS581	1854	
CDT-40-050	Cruceta	49,2	206,4	5-8105X	928	HS585	1850	6H2579
CDT-40-051	Cruceta	49,2	206,31	5-8201X	582	HS582	1852	
CDT-40-052	Cruceta	71,44	209,62	5-9016X	911	HS595	1868	9V7710
CDT-30-032	Cruceta	71,44	209,51	5-9002X	792	HS593	1865	

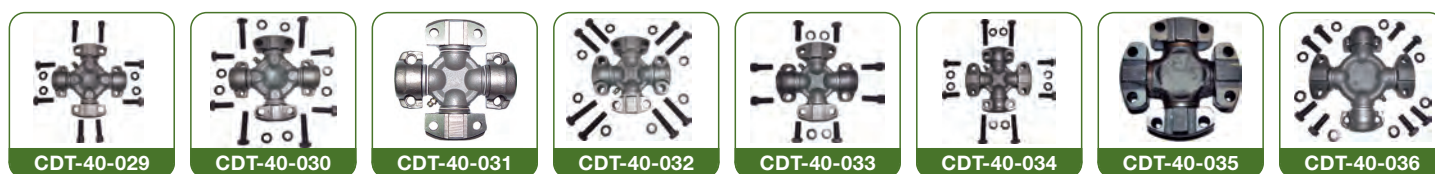

CRUCETAS CAÑA DIRECCIÓN

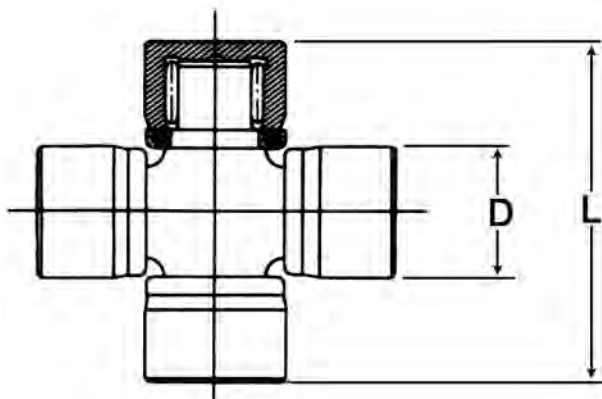

Referencia	Descripción	D (mm)	L (mm)
CDT-50-001	Cruceta	15,0	38,0
CDT-50-002	Cruceta	15,0	39,0
CDT-50-003	Cruceta	15,0	40,0
CDT-50-004	Cruceta	16,0	38,0
CDT-50-005	Cruceta	16,0	39,0
CDT-50-006	Cruceta	16,0	40,0
CDT-50-007	Cruceta	19,0	48,0
CDT-50-008	Cruceta	22,06	64,15
CDT-50-009	Cruceta	22,06	67,10
CDT-50-010	Cruceta	24,06	62,40
CDT-50-011	Cruceta	24,06	74,5
CDT-50-012	Cruceta	24,06	78,0



Línea ODM de juntas homocinéticas y transmisiones completas



- Transmisiones nuevas, no reconstruidas.
- Sin retorno de cascos.
- 2 años de garantía.
- Para vehículos 4x4, turismos y furgonetas.
- Más de 5.000 referencias.
- Nuevas incorporaciones cada mes.



100% de los procesos de fabricación controlados



Materia prima



Forjado



Mecanizado



Tratamiento térmico



Rectificado



Fabricación fuelles



Ensamblaje

ODM:

- Más de 20 años de experiencia en junta homocinética y transmisión.
- Una empresa con más de 1.000 empleados y una superficie de 140.000 m².
- Propietaria de 42 patentes.
- ODM ha invertido más de 30 millones de dólares en 2015.
- Control total de todo el proceso, desde la materia prima hasta los productos acabados.
- ISO/TS16949 alemana.
- ODM ha desarrollado más de 4.000 variedades de junta homocinética.
- La capacidad de producción anual de juntas homocinéticas supera los 8 millones de piezas y ejes de transmisión, 4 millones de unidades.
- Ha obtenido con éxito la ISO14001:2004
- Proveedor primer equipo.

Palieres y homocinéticas



C/. Xaloc, 16 • Pol. Ind. Llevant • 08213 POLINYÀ - (Barcelona) ESPAÑA
 Tels. 902 125 025 - (34) 93 579 90 30 • Fax (34) 93 568 08 14
 info@estanfi.com • www.estanfi.com

