

ESTANFI
AUTOMOCION

BRITPART
ESPAÑA

ESPECIALISTAS EN LAND ROVER, 4x4 y TRANSMISIONES

CAJAS CAMBIO Y TRANSFER DIFERENCIALES Y ACEITES

para Land Rover, 4x4, SUV y turismos

Publicación N.º C-105 Edición 2026



Cajas de cambio automáticas



Cajas de transferencia



Cajas de cambio Land Rover



Diferenciales



Cajas de cambio 4x4



Aceites

Indice general

Cajas Land Rover	3
Cajas 4x4, SUV y Turismo	17
Kits de mantenimiento cajas automáticas ZF	119
Aceites	125
Despieces y cajas doble embrague	131



Las cajas de cambio y de transferencia se suministran con una garantía incluida en el precio de 12 meses sin límite de kilometraje. Todo ello bajo el marco del Sistema de Aseguramiento de la Calidad ISO9001:2015 de ESTANFI AUTOMOCION.

CAJAS LAND ROVER

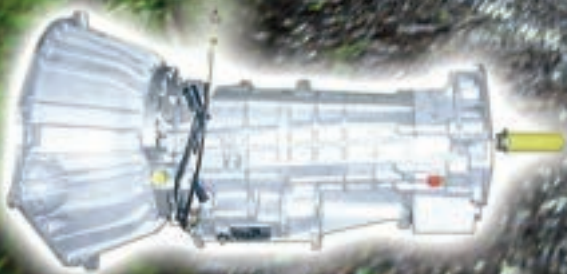

Índice Land Rover

Pág.		Pág.	
5	Santana	14	Kit palanca bloqueo
5	Land Rover Santana	14	Caja dirección hidráulica
6	Land Rover Defender	14	Diferenciales nuevos y reconstruidos
7	Land Rover Discovery	16	Kits reparación diferencial
9	Land Rover Freelander		
10	Range Rover		



Cajas de cambio reconstruidas

Para la correcta identificación de la caja se precisa del número de bastidor del Land Rover, así como del número de caja de cambios. Para cada modelo de caja ilustrado se especifica la localización de la numeración. Este número consta de la siguiente información (dos números, seguidos de la letra "A", cinco números, y seguida al final de otra letra):

Número	Número	Letra	Número	Número	Número	Número	Número	Número	Letra sufijo
—	—	A	—	—	—	—	—	—	—

Ejemplo: 56A25457G: Caja cambios LT77 con sufijo G, para Defender

Cajas de transferencia reconstruidas

Para la correcta identificación de la caja de transferencia o caja transfer o caja "reductora" se precisa del número de bastidor del Land Rover, así como del número de la propia caja.

Para cada modelo de caja ilustrado se especifica la localización de la numeración. Este número consta de la siguiente información (dos números, seguidos de la letra "D", cinco números, y seguida al final de una letra):

Número	Número	Letra	Número	Número	Número	Número	Número	Número	Letra sufijo
—	—	D	—	—	—	—	—	—	—

Ejemplo: 22D54584F: Caja de transferencia LT230 con sufijo F, para Defender



Caja cambios Aníbal

Ref. **791067**. Modelo caja LT85. Caja cambios adaptable a Santana Aníbal. Carcasa desmontable



Caja transfer Aníbal

Ref. **791010**. Caja transfer adaptable a Santana Aníbal. Modelos con caja LT85



Caja cambios Santana

Caja cambios adaptable a Santana E300-350



Land Rover Santana

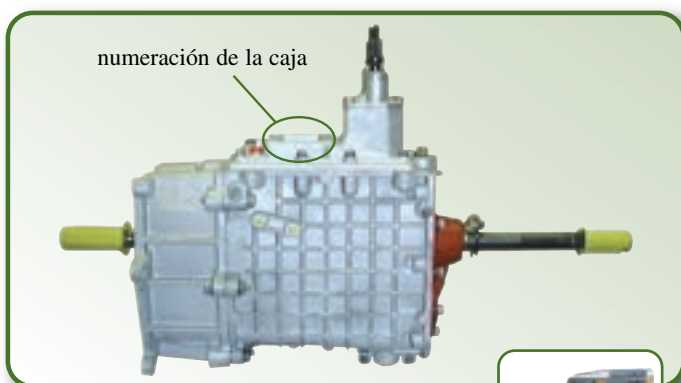

Caja cambios LT85

Caja cambios **manual** de 5 velocidades, modelo LT85. Adaptable a Land Rover Santana

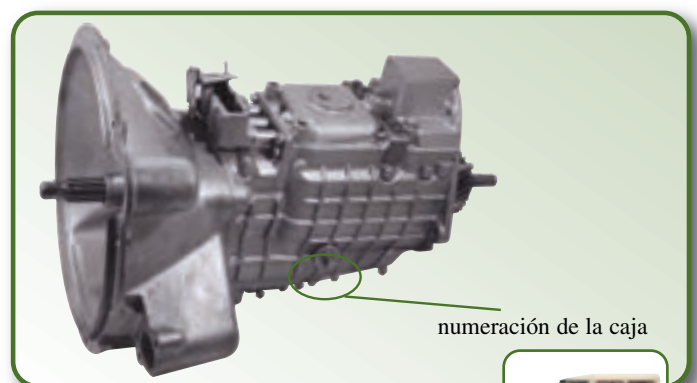

Caja cambios Rover

Caja cambios **manual** sincronizada de 4 velocidades Adaptable a modelos Santana serie II y III



Las cajas de cambio y de transferencia se suministran con una garantía incluida en el precio de 12 meses sin límite de kilometraje. Todo ello bajo el marco del Sistema de Aseguramiento de la Calidad ISO9001:2015 de ESTANFI AUTOMOCION.



Caja cambios LT77 y LT77S

Caja de cambios **manual** de 5 velocidades, modelos LT77 y LT77S. Adaptable a Defender 200 tdi, Defender 90/110, Defender gasolina



Caja cambios R380

Caja de cambios **manual** de 5 velocidades, modelo R380. Adaptable a Defender 90/100 300 tdi, Defender td5, Defender gasolina

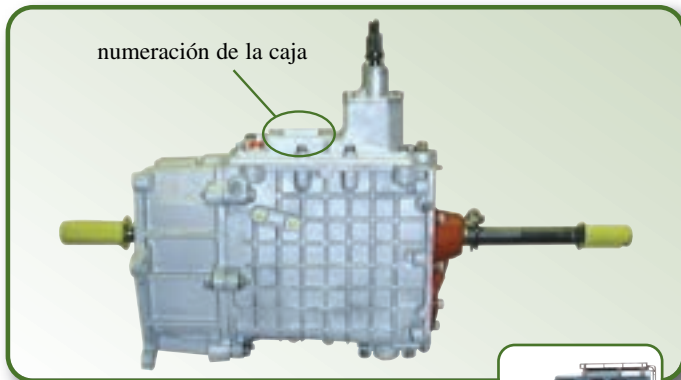

Caja cambios LT85

Caja cambios **manual** de 5 velocidades, modelo LT85. Adaptable a Defender



Caja cambios Puma

Caja de cambios **manual** de 6 velocidades. Adaptable a Defender Puma modelo 2007



Caja transfer LT230 y LT230T

Caja de transferencia modelos LT230 y LT230T. Adaptable a Defender 90/110, 200 tdi, 300 tdi, gasolina, td5 y DF2007



Caja transfer LT230 reforzada

Caja transfer LT230 reforzada. Sustituye el doble eje estándar por un sistema fabricado en una sola pieza. Adaptable a Defender Td5

Las cajas de cambio y de transferencia se suministran con una garantía incluida en el precio de 12 meses sin límite de kilometraje. Todo ello bajo el marco del Sistema de Aseguramiento de la Calidad ISO9001:2015 de ESTANFI AUTOMOCION.



Caja cambios LT77 y LT77S

Caja de cambios **manual** de 5 velocidades, modelos LT77 y LT77S. Adaptable a Discovery 200 tdi, Discovery V8 gasolina



Caja cambios R380 rec

Reacondicionada. Para montar cajas R380 en Defenders con motores 200 Tdi y cajas LT77



Caja cambios R380

Caja de cambios **manual** de 5 velocidades, modelo R380. Adaptable a Discovery 300 tdi, Discovery td5, Discovery gasolina

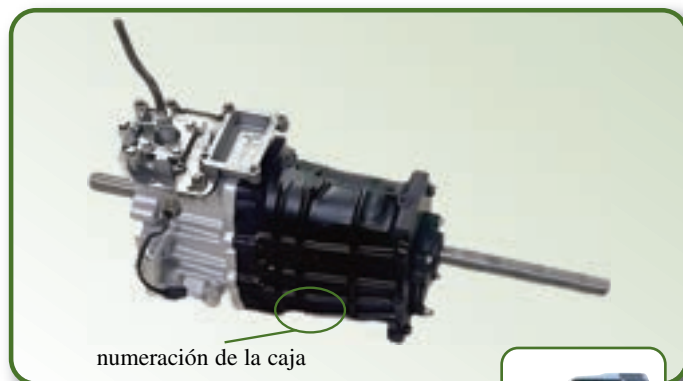

Caja cambios R380 Lock

Igual a la R380 pero varía la tapa. Con sistema de bloqueo del diferencial central del transfer. Para Discovery td5

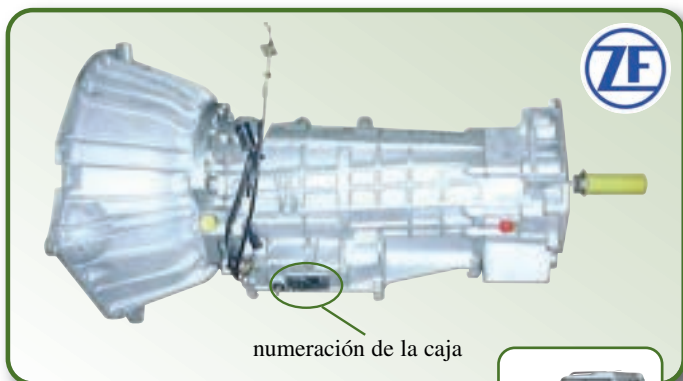

Caja cambios Discovery 1 y 2

Caja cambios **automática** ZF. 2 modelos: hidráulico para Discovery 1 y electrónico para Discovery 2



Caja cambios Discovery 3 y 4

Caja cambios **manual** de 6 velocidades. Adaptable a Discovery 3 y 4

Las cajas de cambio y de transferencia se suministran con una garantía incluida en el precio de 12 meses sin límite de kilometraje. Todo ello bajo el marco del Sistema de Aseguramiento de la Calidad ISO9001:2015 de ESTANFI AUTOMOCION.

Imagen usada como referencia



Caja cambios (L319)

Caja cambios **automática ZF 6 HP 26 X**. Para Discovery 3, 2.7 TD 4x4 de 2004 a 2009.

Imagen usada como referencia

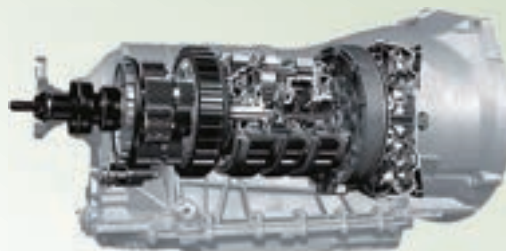

Caja cambios (L319)

Caja cambios **automática ZF 6 HP 26 X**. Para Discovery 3, 4.4 4x4 de 2004 a 2009.

Imagen usada como referencia



Caja cambios (L319)

Caja cambios **automática ZF 6 HP 28 X**. Para Discovery 4, 3.0 TD 4x4 de 2009 a 2018.



Caja transfer LT230 y LT230T

Caja de transferencia modelos LT230 y LT230T. Adaptable a Discovery 200 tdi, 300 tdi, gasolina, serie 1 y serie 2, y Td5



Caja transfer LT230 reforzada

Caja transfer LT230 reforzada. Sustituye el doble eje estándar por un sistema fabricado en una sola pieza. Adaptable a Discovery 2 Td5



Caja transfer Discovery

Caja de transferencia. Adaptable a Discovery 3 y Discovery 4

Las cajas de cambio y de transferencia se suministran con una garantía incluida en el precio de 12 meses sin límite de kilometraje. Todo ello bajo el marco del Sistema de Aseguramiento de la Calidad ISO9001:2015 de ESTANFI AUTOMOCION.



Caja cambios Freelander 1

Caja de cambios **automática** JATCO (para modelos TD4 y V6). Adaptable a Freelander 1



Caja cambios Freelander

Caja de cambios **manual**. Adaptable a Freelander 1.8 gasolina y 2.0 tcie



Caja cambios TD4

Caja de cambios.
Adaptable a Freelander TD4



Caja cambios LR049988

Caja de cambios **manual** 6 velocidades. Adaptable a Freelander II y Evoque 2WD (tracción delantera).



Caja cambios LR014588

Caja cambios **manual** 6 velocidades **SIN** el sistema START/STOP. Son siempre 4WD (tracción 4 ruedas).



Caja cambios LR024707

Caja cambios **manual** 6 velocidades **CON** el sistema START/STOP. Son siempre 4WD (tracción 4 ruedas).

Las cajas de cambio y de transferencia se suministran con una garantía incluida en el precio de 12 meses sin límite de kilometraje. Todo ello bajo el marco del Sistema de Aseguramiento de la Calidad ISO9001:2015 de ESTANFI AUTOMOCION.

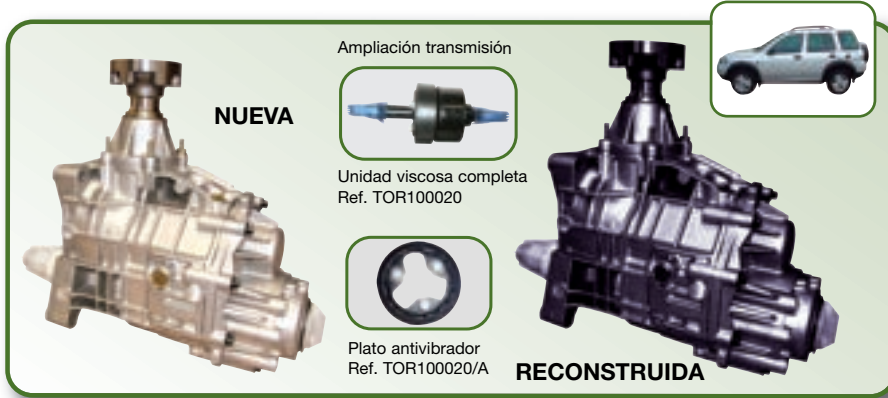

Caja transfer (dif. delantero) Freelander I

Cajas de transferencia nueva y reconstruida.
Adaptable a Freelander I (todos)



Caja transfer (dif. delantero) Freelander II y Evoque

Caja de transferencia.
Adaptable a Freelander II y Evoque.

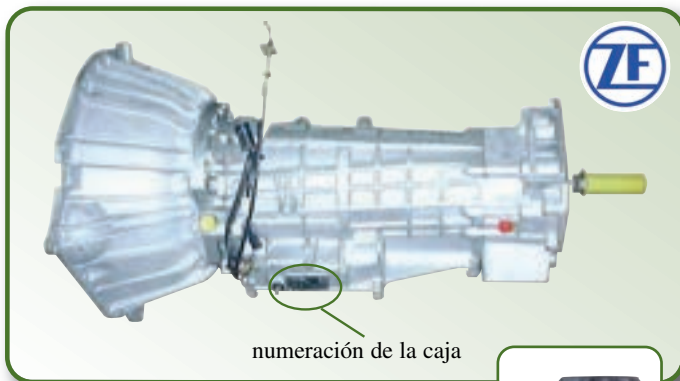

Caja cambios automática ZF

Caja cambios **automática** ZF. Hidráulico para Range Rover Classic y electrónico para New Range Rover



Caja cambios LT77 y LT77S

Caja de cambios **manual** de 5 velocidades. Adaptable a Range Rover 200 tdi, Range Rover V8 gasolina

Las cajas de cambio y de transferencia se suministran con una garantía incluida en el precio de 12 meses sin límite de kilometraje. Todo ello bajo el marco del Sistema de Aseguramiento de la Calidad ISO9001:2015 de ESTANFI AUTOMOCION.



Caja cambios R380

Caja de cambios **manual** de 5 vel. Adaptable a Range Rover 300 tdi, Range Rover P38, Range Rover gasolina



Caja cambios LR024707

Caja cambios **manual** 6 velocidades **CON** el sistema START/STOP. Son siempre 4WD. Adaptable a Evoque

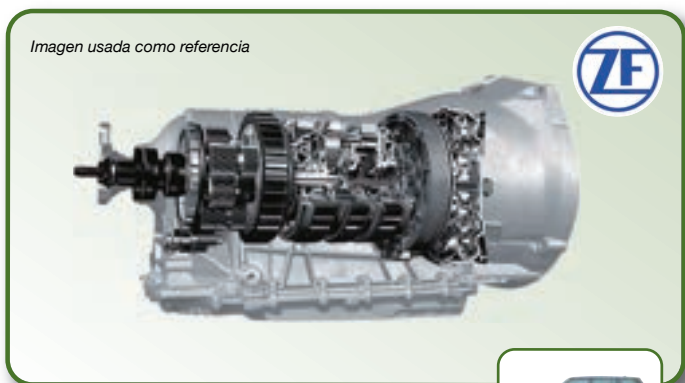

Caja cambios (L322)

Caja de cambios **automática 6 HP 26 X** de 6 velocidades. Para Range Rover III (L322) 4.2 4x4. De 2005 a 2012.

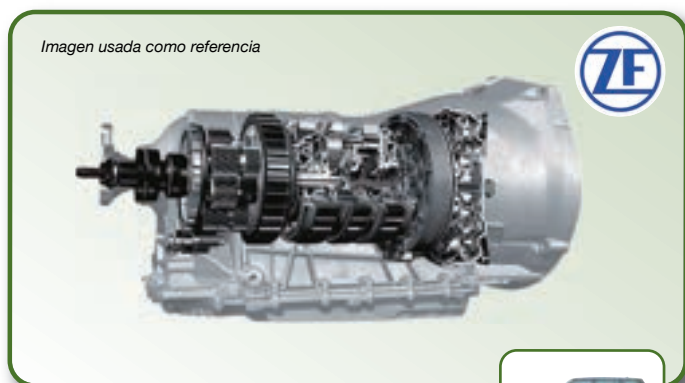

Caja cambios (L322)

Caja de cambios **automática 6 HP 26 X** de 6 velocidades. Para Range Rover III (L322) 4.4 4x4. De 2005 a 2012.

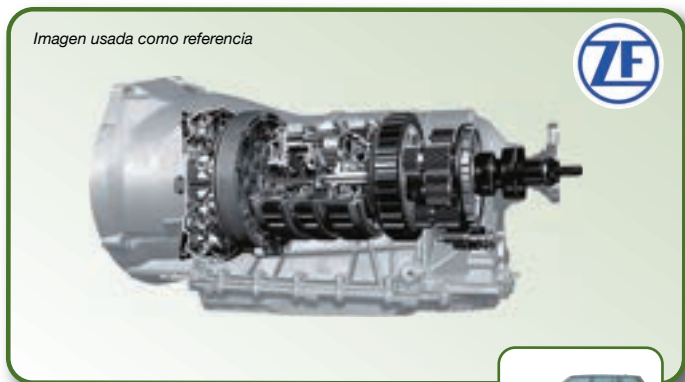

Caja cambios (L322)

Caja de cambios **automática 6 HP 26 X** de 6 velocidades. Para Range Rover III (L322) 5.0 4x4. De 2009 a 2012.



Las cajas de cambio y de transferencia se suministran con una garantía incluida en el precio de 12 meses sin límite de kilometraje. Todo ello bajo el marco del Sistema de Aseguramiento de la Calidad ISO9001:2015 de ESTANFI AUTOMOCION.

Imagen usada como referencia

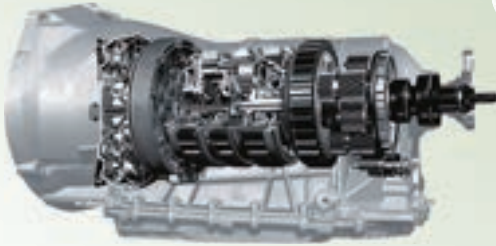

Caja cambios (L320)

Caja de cambios **automática 6 HP 26 X** de 6 velocidades. Para Range Rover Sport (L320) 2.7 D 4x4. De 2005 a 2013.

Imagen usada como referencia



Caja cambios (L320)

Caja de cambios **automática 6 HP 26 X** de 6 velocidades. Para Range Rover Sport (L320) 3.6 D 4x4. De 2006 a 2013.



Unidad viscosa

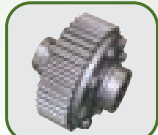

Piñón diferencial



Caja transfer Range Rover

Caja de transferencia. Adaptable a Range Rover Classic, diesel y gasolina.



Unidad viscosa

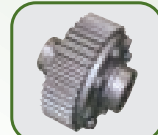

Piñón diferencial



Caja transfer Range Rover P38

Caja de transferencia. Adaptable a New Range Rover (P38). Disponible para modelos con cambio manual y cambio automático, tanto diesel como gasolina



Caja transfer LT230 y LT230T

Caja de transferencia modelos LT230 y LT230T
Adaptable a Range Rover 300 tdi



Caja transfer Range Rover

Caja de transferencia. Adaptable a Range Rover Sport y Range Rover L322 autom. V8 Diesel, de primera y segunda serie. Modelos diesel y gasolina.

Las cajas de cambio y de transferencia se suministran con una garantía incluida en el precio de 12 meses sin límite de kilometraje. Todo ello bajo el marco del Sistema de Aseguramiento de la Calidad ISO9001:2015 de ESTANFI AUTOMOCION.



Caja transfer LR117533

Caja transfer de 1 velocidad. No reductora. Sólo envía por eje trasero con diferencial que reparte más fuerzas. Adaptable a Discovery 4 (2010-2016), Range Rover (2013 en adelante) y Range Sport (2014 en adelante)

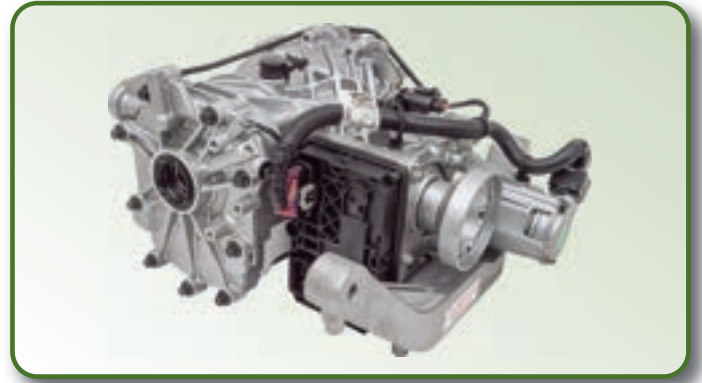

Diferencial trasero Land Rover

Reconstruido. Sustituye al LR052118 Adaptable a Range Rover Evoque (2012-2018) y a Discovery Sport.



Las cajas de cambio y de transferencia se suministran con una garantía incluida en el precio de 12 meses sin límite de kilometraje. Todo ello bajo el marco del Sistema de Aseguramiento de la Calidad ISO9001:2015 de ESTANFI AUTOMOCION.



Kit palanca bloqueo



Kit palanca para LT230 Discovery TD5

Nuevo kit de palanca para todas las LT230 que dispongan de preinstalación de bloqueo. Con este nuevo kit podrá usted, desde el interior de su vehículo, seleccionar cortas, largas y, a partir de instalar nuestro kit también podrá bloquear (siempre y cuando la caja de transferencia esté preparada para ello).



Caja dirección hidráulica



Caja dirección

Ref. **STC2845 - STC2845/RECON - STC2845/RECON2 - STC2845/RECON3**. Conjuntos caja de dirección reconstruida.

Adaptable a Defender, Discovery y Range Rover. Calidad originales.



Diferenciales nuevos y reconstruidos



Diferencial delantero y trasero

Ref. **FTC3272/RECON**. Modelo eje simple. Con 2 satélites y 2 planetarios. Adaptable a Defender, Discovery, Range Rover, Land Rover Santana, Santana Anibal y Freelander.



Diferencial delantero Land Rover

Ref. **FTC3272E/RR**. Alternativa "REFORZADA" al diferencial delantero estándar. Diferencial reforzado de 4 PIN (2 satélites y 4 planetarios) en vez del estándar de 2 PIN.

Diferenciales nuevos y reconstruidos



Diferencial delantero y trasero

Ref. **TBB000270/RECON**. Modelo reforzado. Con doble eje, 4 satélites y 2 planetarios. Adaptable a Defender, Discovery y Range Rover.

Ref. **TBB000270/2PIN**. Modelo con 2 pines internos en lugar de 4

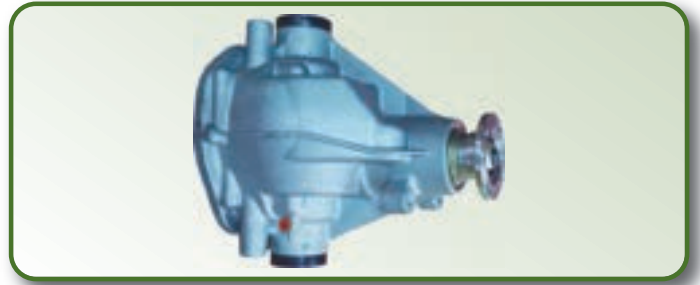

Diferencial Freelander 1

Ref. **TVK100380E**. Diferencial trasero **nuevo**. Adaptable a Freelander 1



Diferencial Freelander 1

Ref. **TVK100380E/RECON**. Diferencial trasero. Adaptable a Freelander 1. Color negro



Diferencial Freelander 2

Ref. **LR030852**. Diferencial trasero **reconstruido**. Adaptable a Freelander 2



Diferencial Freelander 2

Ref. **DA1216**. Diferencial trasero **nuevo**. Adaptable a Freelander 2



Diferencial delantero

Ref. **TAG500140**. Diferencial delantero **nuevo** para cambio automático. Adaptable Discovery 3, Discovery 4 (diesel) y Range Rover Sport (hasta 2013)



Diferencial delantero

Ref. **TAG500150**. Diferencial delantero **nuevo**. Adaptable a modelos con cambio manual de 6 velocidades: Discovery 3 y Discovery 4 (diesel)



Diferencial delantero

Ref. **TAG500160**. Diferencial delantero **nuevo**. Adaptable a modelos gasolina: Discovery 3, Discovery 4 y Range Rover Sport (hasta 2009)

Diferenciales nuevos y reconstruidos



Diferencial trasero

Ref. **TVK500240**. Diferencial trasero **nuevo**. Adaptable a modelos con cambio automático: Discovery 3 y Discovery 4 (diesel y gasolina), Range Rover Sport (hasta 2013) (diesel y gasolina)



Diferencial trasero

Ref. **TVK500250**. Diferencial trasero **nuevo**. Sin bloqueo. Adaptable a modelos con cambio manual Discovery 3 (diesel)



Diferencial trasero

Ref. **TAG500420**. Diferencial trasero **nuevo**. Sin bloqueo. Adaptable a modelos con cambio automático Discovery 3 (gasolina) y Range Rover Sport (gasolina) (hasta 2009)



Diferencial trasero

Ref. **TAG500260**. Diferencial delantero **nuevo**. Sin bloqueo. Adaptable a modelos con cambio automático: Discovery 3 y Discovery 4 (gasolina), Range Rover Sport (gasolina) (hasta 2009)

Kits reparación diferencial

Freelander 2

Kit reparación del cojinete del piñón del diferencial trasero con aceites

DA7211 Freelander 2 - hasta BH257090

DA7214 Freelander 2 - desde BH257091

Kit reparación del cojinete del piñón del diferencial trasero

DA7211E Freelander 2 - hasta BH257090

DA7214E Freelander 2 - desde BH257091

Kit reparación del cojinete del piñón del diferencial trasero completo con aceites

DA7509 Freelander 2 - hasta BH257090

DA7529 Freelander 2 - desde BH257091

Kit reparación del cojinete del piñón del diferencial trasero completo

DA7509E Freelander 2 - hasta BH257090

DA7529E Freelander 2 - desde BH257091

Kit reparación diferencial delantero

DA7213E Freelander 2

Discovery 3 / Discovery 4 Range Rover Sport (2005 - 2013)

DA5039

Kit reparación diferencial delantero 4 rodamientos y 3 gomas sellantes

DA5035

Kit reparación dif. trasero sin bloqueo 6 rodamientos y 3 gomas sellantes

DA5038

Kit reparación dif. de bloqueo trasero 5 rodamientos y 3 gomas sellantes

DA7509



Discovery 5 / Range Rover Sport (2014) - Range Rover L405

DA7216

Kit rep. dif. delantero

DA7217

Kit rep. dif. trasero

DA5039



DA7529E



CAJAS 4x4, SUV y TURISMOS



Índice 4x4, SUV y turismos

Pág.		Pág.		Pág.	
19	Alpina	66	Isuzu	93	Renault
19	Aston Martin	66	Jaguar	93	Rolls-Royce
20	Audi	69	Jeep	94	Seat
30	Bentley	71	Kia	95	Skoda
31	BMW	72	Lincoln	98	Subaru
62	Chrysler	72	Maserati	98	Suzuki
62	Daihatsu	73	Mazda	101	Toyota
62	Dodge	74	Mercedes	102	Ssangyong
63	Fiat	86	Mitsubishi	103	Volvo
64	Ford	87	Nissan	104	Volkswagen
65	Honda	90	Opel		
65	Hyundai	91	Porsche		

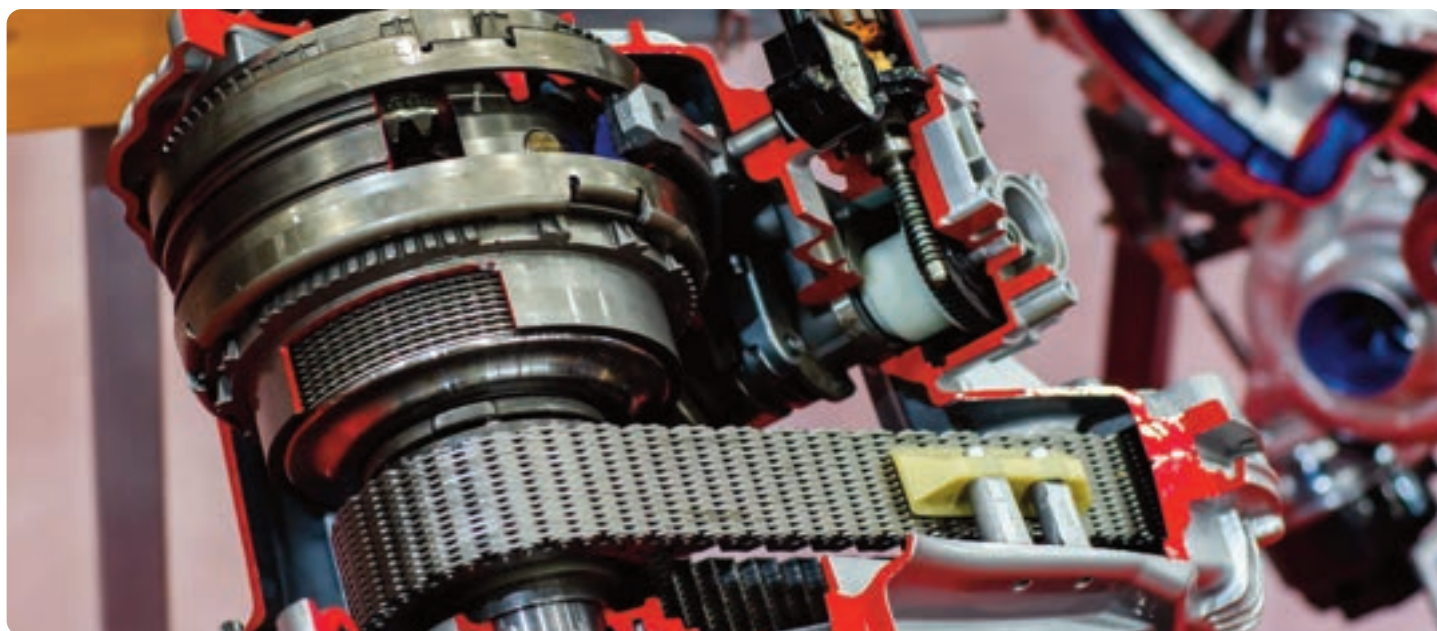

CAJAS DE CAMBIO Y CAJAS DE TRANSFERENCIA RECONSTRUIDAS

Las cajas de cambio y cajas de transferencias se suministran con una garantía incluida en el precio de 12 meses sin límite de kilometraje; todo ello según las condiciones que se reflejan en esta publicación y bajo el marco del Sistema de Aseguramiento de la Calidad ISO9001:2015 de ESTANFI AUTOMOCION.

Para la correcta identificación de la caja de cambios se precisa la siguiente información:

- Marca constructora y modelo del vehículo
- Año de fabricación
- Cilindrada
- Número de bastidor

B7 (F01, F02)

Imagen usada como referencia

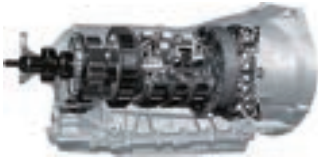

EST-1068042147000



Cajas de cambio automáticas 6 HP 28

Modelo	kW/HP	Año	Caja	Referencia
BITURBO	373/507	03/2009-06/2012	6AT	EST-1068042147000

Aston Martin



DB9 Vantage

Imagen usada como referencia

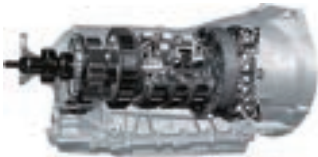

EST-1068022073800



Cajas de cambio automáticas 6 HP 28

Modelo	kW/HP	Año	Caja	Referencia
6.0 V12	331/450	01/2004-10/2016	6AT	EST-1068022073800
6.0 V12	331/450	01/2004-10/2016	6AT	EST-1068022109800
6.0 V12	331/450	01/2004-10/2016	6AT	EST-1068022145000

DB9 Volante

Imagen usada como referencia

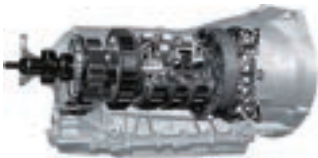

EST-1068022109800



Cajas de cambio automáticas 6 HP 26 X

Modelo	kW/HP	Año	Caja	Referencia
6.0 V12	331/450	04/2004-07/2012	6AT	EST-1068022073800
6.0 V12	331/450	04/2004-07/2012	6AT	EST-1068022109800

Rapide

Imagen usada como referencia

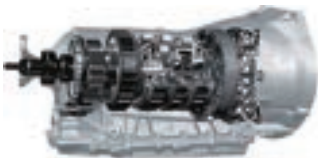

EST-1068022172800



Cajas de cambio automáticas 6 HP 26 X

Modelo	kW/HP	Año	Caja	Referencia
6.0	350/476	03/2010-09/2013	6AT	EST-1068022172800

Audi A3 (8L1)



TT03-95-016



TT03-95-017

Diferencial trasero

Modelo	kW/HP	Año	Caja	Referencia
1.8 T quattro	132/180	10/1998-05/2003	6MT	TT03-95-016
1.8 T quattro	132/180	10/1998-05/2003	5MT	TT03-95-016
1.9 TDI quattro	96/130	08/2000-05/2003	6MT	TT03-95-017
S3 quattro	154/210	03/1999-04/2002	6MT	TT03-95-016
S3 quattro	165/224	10/2001-05/2003	6MT	TT03-95-016

Audi A3 (8P1)



TT02-95-006

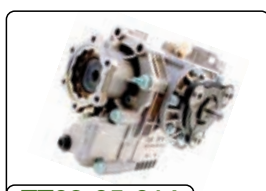

TT02-95-014



TT03-95-005



TT03-95-006



TT03-95-008

Diferencial delantero

Modelo	kW/HP	Año	Caja	Referencia
1.8 TFSI quattro	118/160	07/2008-08/2012	6MT	TT02-95-006
2.0 TDI 16V quattro	103/140	08/2004-08/2012	6AT	TT02-95-014
2.0 TDI 16V quattro	103/140	08/2004-08/2012	6MT	TT02-95-006
2.0 TDI quattro	100/136	05/2003-06/2008	6AT	TT02-95-014
2.0 TDI quattro	100/136	05/2003-06/2008	6MT	TT02-95-006
2.0 TDI quattro	103/140	01/2006-06/2008	6AT	TT02-95-014
2.0 TDI quattro	103/140	01/2006-06/2008	6MT	TT02-95-006
2.0 TDI quattro	125/170	03/2006-08/2012	6AT	TT02-95-014
2.0 TDI quattro	125/170	03/2006-08/2012	6MT	TT02-95-006
2.0 TFSI quattro	147/200	09/2004-08/2012	6AT	TT02-95-014
2.0 TFSI quattro	147/200	09/2004-08/2012	6MT	TT02-95-006
3.2 V6 quattro	184/250	07/2003-05/2009	6AT	TT02-95-014
3.2 V6 quattro	184/250	07/2003-05/2009	6MT	TT02-95-006
3.2 quattro	186/253	09/2005-12/2009	6MT	TT02-95-006
3.2 quattro	186/253	09/2005-12/2009	6AT	TT02-95-014
S3 quattro	188/256	02/2007-08/2012	6MT	TT02-95-006
S3 quattro	188/256	02/2007-08/2012	6AT	TT02-95-014
S3 quattro	195/265	11/2006-08/2012	6MT	TT02-95-006
S3 quattro	195/265	11/2006-08/2012	6AT	TT02-95-014

Diferencial trasero

Modelo	kW/HP	Año	Caja	Referencia
1.8 TFSI quattro	118/160	07/2008-08/2012	7AT	TT03-95-008
1.8 TFSI quattro	118/160	07/2008-08/2012	6MT	TT03-95-008
2.0 TDI 16V quattro	103/140	08/2004-08/2012	6MT	TT03-95-006
2.0 TDI 16V quattro	103/140	08/2004-08/2012	6AT	TT03-95-006
2.0 TDI quattro	100/136	05/2003-06/2008	6MT	TT03-95-006
2.0 TDI quattro	100/136	05/2003-06/2008	6AT	TT03-95-006
2.0 TDI quattro	103/140	01/2006-06/2008	6AT	TT03-95-006
2.0 TDI quattro	103/140	01/2006-06/2008	6MT	TT03-95-006
2.0 TDI quattro	125/170	03/2006-06/2008	6MT	TT03-95-006
2.0 TDI quattro	125/170	06/2008-08/2012	6MT	TT03-95-008
2.0 TDI quattro	125/170	06/2008-08/2012	6AT	TT03-95-008
2.0 TDI quattro	125/170	06/2008-08/2012	6AT	TT03-95-006
2.0 TFSI quattro	147/200	09/2004-06/2008	6MT	TT03-95-005
2.0 TFSI quattro	147/200	09/2004-06/2008	6AT	TT03-95-005
2.0 TFSI quattro	147/200	07/2008-08/2012	6MT	TT03-95-008
2.0 TFSI quattro	147/200	07/2008-08/2012	6AT	TT03-95-008
3.2 V6 quattro	184/250	07/2003-06/2008	6AT	TT03-95-005
3.2 V6 quattro	184/250	07/2003-06/2008	6MT	TT03-95-005
3.2 V6 quattro	184/250	07/2008-05/2009	6MT	TT03-95-008
3.2 V6 quattro	184/250	07/2008-05/2009	6AT	TT03-95-008
3.2 quattro	186/253	09/2005-06/2008	6AT	TT03-95-005
3.2 quattro	186/253	09/2005-06/2008	6MT	TT03-95-005
3.2 quattro	186/253	07/2008-12/2009	6MT	TT03-95-008
3.2 quattro	186/253	07/2008-12/2009	6AT	TT03-95-008
S3 quattro	188/256	02/2007-06/2008	6MT	TT03-95-005
S3 quattro	188/256	02/2007-06/2008	6AT	TT03-95-005
S3 quattro	188/256	07/2008-08/2012	6MT	TT03-95-008
S3 quattro	188/256	07/2008-08/2012	6AT	TT03-95-008
S3 quattro	195/265	11/2006-06/2008	6MT	TT03-95-005
S3 quattro	195/265	11/2006-08/2012	6AT	TT03-95-008
S3 quattro	195/265	07/2008-08/2012	6AT	TT03-95-005
S3 quattro	195/265	07/2008-08/2012	6MT	TT03-95-008



Audi A3 Sportback (8PA)



TT02-95-006



TT02-95-014



TT03-95-005



TT03-95-006



TT03-95-008

Diferencial delantero

Modelo	kW/HP	Año	Caja	Referencia
1.8 TFSI quattro	118/160	07/2008-03/2013	6MT	TT02-95-006
2.0 TDI 16V quattro	103/140	11/2005-03/2013	6MT	TT02-95-006
2.0 TDI 16V quattro	103/140	11/2005-03/2013	6AT	TT02-95-014
2.0 TDI quattro	103/140	01/2006-06/2008	6MT	TT02-95-006
2.0 TDI quattro	103/140	01/2006-06/2008	6AT	TT02-95-014
2.0 TDI quattro	125/170	03/2006-03/2013	6AT	TT02-95-014
2.0 TDI quattro	125/170	03/2006-03/2013	6MT	TT02-95-006
2.0 TFSI quattro	147/200	09/2004-03/2013	6AT	TT02-95-014
2.0 TFSI quattro	147/200	09/2004-03/2013	6MT	TT02-95-006
3.2 V6 quattro	184/250	09/2004-05/2009	6AT	TT02-95-014
3.2 V6 quattro	184/250	09/2004-05/2009	6MT	TT02-95-006
S3 quattro	188/256	07/2008-03/2013	6AT	TT02-95-014
S3 quattro	188/256	07/2008-03/2013	6MT	TT02-95-006
S3 quattro	195/265	06/2008-03/2013	6MT	TT02-95-006
S3 quattro	195/265	06/2008-03/2013	6AT	TT02-95-014

Diferencial trasero

Modelo	kW/HP	Año	Caja	Referencia
1.8 TFSI quattro	118/160	07/2008-03/2013	6MT	TT03-95-008
1.8 TFSI quattro	118/160	07/2008-03/2013	7AT	TT03-95-008
2.0 TDI 16V quattro	103/140	11/2005-03/2013	6AT	TT03-95-006
2.0 TDI 16V quattro	103/140	11/2005-03/2013	6MT	TT03-95-006
2.0 TDI quattro	103/140	01/2006-06/2008	6AT	TT03-95-006
2.0 TDI quattro	103/140	01/2006-06/2008	6MT	TT03-95-006
2.0 TDI quattro	125/170	03/2006-06/2008	6MT	TT03-95-006
2.0 TDI quattro	125/170	03/2006-06/2008	6AT	TT03-95-006
2.0 TDI quattro	125/170	07/2008-03/2013	6AT	TT03-95-008
2.0 TDI quattro	125/170	07/2008-03/2013	6MT	TT03-95-008
2.0 TFSI quattro	147/200	09/2004-06/2008	6MT	TT03-95-005
2.0 TFSI quattro	147/200	09/2004-06/2008	6AT	TT03-95-005
2.0 TFSI quattro	147/200	09/2004-03/2013	6MT	TT03-95-008
2.0 TFSI quattro	147/200	07/2008-03/2013	6AT	TT03-95-008
3.2 V6 quattro	184/250	09/2004-05/2009	6AT	TT03-95-005
3.2 V6 quattro	184/250	09/2004-05/2009	6MT	TT03-95-005
RS3 quattro	250/340	01/2011-12/2012	7AT	TT03-95-008
S3 quattro	188/256	07/2008-03/2013	6AT	TT03-95-008
S3 quattro	188/256	07/2008-03/2013	6MT	TT03-95-008
S3 quattro	195/265	06/2008-03/2013	6AT	TT03-95-008
S3 quattro	195/265	06/2008-03/2013	6MT	TT03-95-008

A4 B7 (8EC)

Imagen usada como referencia



EST-1071042390800



Cajas de cambio automáticas 6 HP 21 A

Modelo	kW/HP	Año	Caja	Referencia
2.0 TFSI quattro	162/220	06/2005-06/2008	6AT	EST-1071042390800
3.0 TDI quattro	150/204	11/2004-06/2008	6AT	EST-1071042216800
3.0 TDI quattro	150/204	11/2004-06/2008	6AT	EST-1071042309800
3.0 TDI quattro	171/233	01/2006-06/2008	6AT	EST-1071042309800
S4 quattro	253/344	11/2004-06/2008	6AT	EST-1071042301000

A4 B7 Avant (8ED)

Imagen usada como referencia

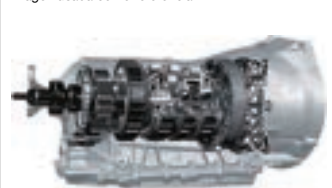

EST-1071042216800



Cajas de cambio automáticas 6 HP 19 A

Modelo	kW/HP	Año	Caja	Referencia
3.0 TDI quattro	150/204	11/2004-06/2008	6AT	EST-1071042216800
3.0 TDI quattro	150/204	11/2004-06/2008	6AT	EST-1071042309800
3.0 TDI quattro	171/233	01/2006-06/2008	6AT	EST-1071042309800
S4 quattro	253/344	11/2004-06/2008	6AT	EST-1071042301000

A4 B7 Descapotable (8HE)

Imagen usada como referencia

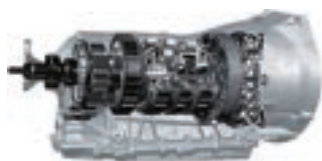

EST-1071042309800



Cajas de cambio automáticas 6 HP 19 A

Modelo	kW/HP	Año	Caja	Referencia
3.0 TDI quattro	171/233	01/2006-03/2009	6AT	EST-1071042309800
3.0 TDI quattro	150/204	01/2006-03/2009	6AT	EST-1071042309800

ALLROAD C5 (4BH)



TT04-95-002



TT04-95-001

Cajas de transfer

Modelo	kW/HP	Año	Caja	Referencia
2.5 TDI quattro	120/163	05/2003-08/2005	6MT	TT04-95-001
2.5 TDI quattro	132/180	05/2000-08/2005	6MT	TT04-95-001
2.7 T quattro	184/250	05/2000-08/2005	6MT	TT04-95-002

A6 C6 (4F2)

Imagen usada como referencia

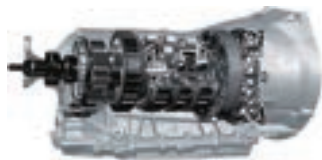

EST-1071042303800



Cajas de cambio automáticas 6 HP 19 A

Modelo	kW/HP	Año	Caja	Referencia
2.7 TDI quattro	120/163	06/2005-03/2011	6AT	EST-1071042303800
2.7 TDI quattro	132/180	11/2004-10/2008	6AT	EST-1071042303800
2.7 TDI quattro	140/190	10/2008-03/2011	6AT	EST-1071042421000
3.0 quattro	160/218	05/2004-05/2006	6AT	EST-1071042152800
3.0 TDI quattro	155/211	05/2004-03/2011	6AT	EST-1071042266800
3.0 TDI quattro	155/211	05/2004-03/2011	6AT	EST-1071042294800
3.0 TDI quattro	165/225	05/2004-05/2006	6AT	EST-1071042266800
3.0 TDI quattro	171/233	06/2006-10/2008	6AT	EST-1071042294800
3.0 TDI quattro	171/233	06/2006-10/2008	6AT	EST-1071042449000
3.2 FSI quattro	188/255	05/2004-10/2008	6AT	EST-1071042349800
4.2 quattro	246/335	05/2004-05/2006	6AT	EST-1071042080800
4.2 quattro	246/335	05/2004-05/2006	6AT	EST-1071042183800

Cajas de cambio automáticas 6 HP 26 A 61

Modelo	kW/HP	Año	Caja	Referencia
S6 quattro	320/435	03/2006-03/2011	6AT	EST-1068032225800

A6 C6 Avant (4F5)

Imagen usada como referencia

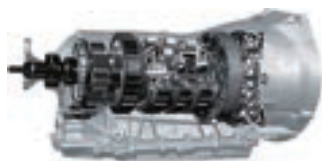

EST-1071042303800



Cajas de cambio automáticas 6 HP 19 A

Modelo	kW/HP	Año	Caja	Referencia
2.7 TDI quattro	120/163	06/2005-08/2011	6AT	EST-1071042303800
2.7 TDI quattro	132/180	11/2004-10/2008	6AT	EST-1071042303800
3.0 TDI quattro	155/211	03/2005-08/2011	6AT	EST-1071042294800
3.0 TDI quattro	171/233	06/2006-10/2008	6AT	EST-1071042294800
3.2 FSI quattro	188/255	03/2005-10/2008	6AT	EST-1071042349800
4.2 quattro	246/335	03/2005-05/2006	6AT	EST-1071042183800

A6 Allroad C6 (4FH)

Imagen usada como referencia



EST-1071042309800



Cajas de cambio automáticas 6 HP 19 A

Modelo	kW/HP	Año	Caja	Referencia
2.7 TDI quattro	120/163	05/2006-08/2011	6AT	EST-1071042378800
2.7 TDI quattro	132/180	03/2006-10/2008	6AT	EST-1071042280800
2.7 TDI quattro	132/180	03/2006-10/2008	6AT	EST-1071042378800
3.0 TDI quattro	155/211	05/2006-08/2011	6AT	EST-1071042379000
3.0 TDI quattro	171/233	05/2006-10/2008	6AT	EST-1071042297800
3.0 TDI quattro	171/233	05/2006-10/2008	6AT	EST-1071042379000

A8 D3 (4E2, 4E8)

Imagen usada como referencia

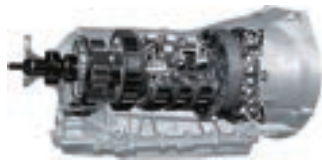

EST-1071042309800



Cajas de cambio automáticas 6 HP 19 A

Modelo	kW/HP	Año	Caja	Referencia
3.0 TDI quattro	155/211	11/2003-07/2010	6AT	EST-1071042268800
3.0 TDI quattro	155/211	11/2003-07/2010	6AT	EST-1071042287800
3.0 TDI quattro	155/211	11/2003-07/2010	6AT	EST-1071042394800
3.0 TDI quattro	171/233	08/2003-07/2010	6AT	EST-1071042268800
3.0 TDI quattro	171/233	08/2003-07/2010	6AT	EST-1071042287800
3.0 TDI quattro	171/233	08/2003-07/2010	6AT	EST-1071042394800
4.2 FSI quattro	257/350	06/2006-07/2010	6AT	EST-1071042422800
6.0 W12 quattro	331/450	12/2003-07/2010	6AT	EST-1068032218000

Cajas de cambio automáticas 6 HP 26 A 61

Modelo	kW/HP	Año	Caja	Referencia
4.2 quattro	246/335	10/2002-07/2010	6AT	EST-1068032053800
4.2 quattro	246/335	10/2002-07/2010	6AT	EST-1068032057800
4.2 TDI quattro	240/326	07/2005-07/2010	6AT	EST-1068032175800



Audi Q3 (8UB, 8UG)



TT02-95-010



TT02-95-006



TT02-95-012

Diferencial delantero

Modelo	kW/HP	Año	Caja	Referencia
2.0 TDI quattro	103/140	01/2012-04/2015	7AT	TT02-95-012
2.0 TDI quattro	103/140	01/2012-04/2015	6MT	TT02-95-006
2.0 TDI quattro	103/140	01/2012-04/2015	6MT	TT02-95-010
2.0 TDI quattro	110/150	11/2014-04/2015	6MT	TT02-95-006
2.0 TDI quattro	110/150	11/2014-	7AT	TT02-95-012
2.0 TDI quattro	120/163	06/2011-04/2015	6MT	TT02-95-006
2.0 TDI quattro	120/163	06/2011-04/2015	6MT	TT02-95-010
2.0 TDI quattro	120/163	06/2011-	7AT	TT02-95-012
2.0 TDI quattro	130/177	06/2011-04/2015	6MT	TT02-95-006
2.0 TDI quattro	130/177	06/2011-	7AT	TT02-95-012
2.0 TDI quattro	130/177	05/2013-04/2015	6MT	TT02-95-010
2.0 TDI quattro	135/184	05/2013-04/2015	6MT	TT02-95-010
2.0 TDI quattro	135/184	11/2014-04/2015	6MT	TT02-95-006
2.0 TDI quattro	135/184	11/2014-	7AT	TT02-95-012

Diferencial delantero

Modelo	kW/HP	Año	Caja	Referencia
2.0 TFSI quattro	125/170	06/2011-04/2015	6MT	TT02-95-006
2.0 TFSI quattro	125/170	06/2011-04/2015	7AT	TT02-95-012
2.0 TFSI quattro	125/170	05/2013-04/2015	6MT	TT02-95-010
2.0 TFSI quattro	132/180	11/2014-04/2015	7AT	TT02-95-012
2.0 TFSI quattro	132/180	11/2014-04/2015	6MT	TT02-95-006
2.0 TFSI quattro	147/200	09/2014-04/2015	6MT	TT02-95-010
2.0 TFSI quattro	147/200	09/2014-04/2015	7AT	TT02-95-012
2.0 TFSI quattro	147/200	09/2014-04/2015	6MT	TT02-95-006
2.0 TFSI quattro	155/211	06/2011-04/2015	6MT	TT02-95-006
2.0 TFSI quattro	155/211	06/2011-04/2015	7AT	TT02-95-012
2.0 TFSI quattro	162/220	05/2013-	7AT	TT02-95-012
2.0 TFSI quattro	162/220	11/2014-04/2015	6MT	TT02-95-006
RS 2.5 quattro	228/310	10/2013-	7AT	TT02-95-012
RS 2.5 quattro	250/340	05/2013-	7AT	TT02-95-012
RS 2.5 quattro	270/367	01/2015-	7AT	TT02-95-012



Audi Q3 (8UB, 8UG)



TT03-95-013



TT03-95-020



TT03-95-021



TT03-95-014

Diferencial trasero				
Modelo	kW/HP	Año	Caja	Referencia
2.0 TDI quattro	103/140	01/2012-11/2013	7AT	TT03-95-020
2.0 TDI quattro	103/140	01/2012-11/2013	6MT	TT03-95-020
2.0 TDI quattro	103/140	11/2013-	7AT	TT03-95-014
2.0 TDI quattro	103/140	11/2013-	6MT	TT03-95-014
2.0 TDI quattro	110/150	11/2014-	6MT	TT03-95-014
2.0 TDI quattro	110/150	11/2014-	7AT	TT03-95-014
2.0 TDI quattro	120/163	06/2011-09/2011	6MT	TT03-95-013
2.0 TDI quattro	120/163	06/2011-09/2011	7AT	TT03-95-013
2.0 TDI quattro	120/163	09/2011-11/2013	6MT	TT03-95-020
2.0 TDI quattro	120/163	09/2011-11/2013	7AT	TT03-95-020
2.0 TDI quattro	120/163	11/2013-	6MT	TT03-95-014
2.0 TDI quattro	120/163	11/2013-	7AT	TT03-95-014
2.0 TDI quattro	130/177	06/2011-09/2011	7AT	TT03-95-013
2.0 TDI quattro	130/177	06/2011-09/2011	6MT	TT03-95-013
2.0 TDI quattro	130/177	09/2011-11/2013	7AT	TT03-95-020
2.0 TDI quattro	130/177	09/2011-11/2013	6MT	TT03-95-020
2.0 TDI quattro	130/177	11/2013-	6MT	TT03-95-014
2.0 TDI quattro	130/177	11/2013-	7AT	TT03-95-014
2.0 TDI quattro	130/177	11/2013-	7AT	TT03-95-014
2.0 TDI quattro	135/184	11/2014-	7AT	TT03-95-014
2.0 TDI quattro	135/184	11/2014-	6MT	TT03-95-014
2.0 TFSI quattro	125/170	06/2011-09/2011	7AT	TT03-95-013

Diferencial trasero				
Modelo	kW/HP	Año	Caja	Referencia
2.0 TFSI quattro	125/170	06/2011-09/2011	6MT	TT03-95-013
2.0 TFSI quattro	125/170	09/2011-11/2013	7AT	TT03-95-020
2.0 TFSI quattro	125/170	09/2011-11/2013	6MT	TT03-95-020
2.0 TFSI quattro	125/170	11/2013-	6MT	TT03-95-014
2.0 TFSI quattro	125/170	11/2013-	7AT	TT03-95-014
2.0 TFSI quattro	132/180	11/2014-	7AT	TT03-95-014
2.0 TFSI quattro	132/180	11/2014-	6MT	TT03-95-014
2.0 TFSI quattro	147/200	09/2014-	7AT	TT03-95-014
2.0 TFSI quattro	147/200	09/2014-	6MT	TT03-95-014
2.0 TFSI quattro	155/211	06/2011-09/2011	6MT	TT03-95-013
2.0 TFSI quattro	155/211	06/2011-09/2011	7AT	TT03-95-013
2.0 TFSI quattro	155/211	09/2011-11/2013	7AT	TT03-95-020
2.0 TFSI quattro	155/211	09/2011-11/2013	6MT	TT03-95-020
2.0 TFSI quattro	155/211	11/2013-	6MT	TT03-95-014
2.0 TFSI quattro	155/211	11/2013-	7AT	TT03-95-014
2.0 TFSI quattro	162/220	11/2014-	7AT	TT03-95-014
2.0 TFSI quattro	162/220	11/2014-	6MT	TT03-95-014
RS 2.5 quattro	228/310	10/2013-	7AT	TT03-95-021
RS 2.5 quattro	250/340	05/2013-	7AT	TT03-95-021
RS 2.5 quattro	270/367	01/2015-	7AT	TT03-95-021



Audi Q7 (4LB)

Imagen usada como referencia

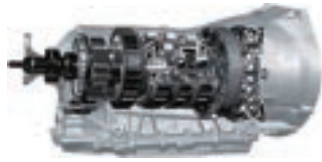

EST-1071022028000



Cajas de cambio automáticas 6 HP 19 X

Modelo	kW/HP	Año	Caja	Referencia
3.6 FSI quattro	206/280	08/2006-05/2010	6AT	EST-1071022028000
6.0 TDI quattro	368/500	09/2008-05/2014	6AT	EST-1070032006000



TT01-95-018



TT01-95-021



TT01-95-017

Cajas de transfer

Modelo	kW/HP	Año	Caja	Referencia
3.0 TDI quattro	150/204	05/2010-08/2015	8DCT	TT01-95-018
3.0 TDI quattro	165/224	06/2009-05/2012	8DCT	TT01-95-018
3.0 TDI quattro	176/240	11/2007-04/2010	8DCT	TT01-95-018
3.0 TDI quattro	180/245	05/2011-08/2015	8DCT	TT01-95-018
3.0 TDI quattro	209/284	09/2008-12/2010	8DCT	TT01-95-017
3.0 TFSI quattro	200/272	05/2010-08/2015	8DCT	TT01-95-017

Cajas de transfer

Modelo	kW/HP	Año	Caja	Referencia
3.0 TFSI quattro	206/280	05/2011-08/2015	8DCT	TT01-95-017
3.0 TFSI quattro	245/333	05/2010-08/2015	8DCT	TT01-95-017
3.6 FSI quattro	206/280	08/2006-05/2010	6MT	TT01-95-018
3.6 FSI quattro	206/280	08/2006-05/2010	6AT	TT01-95-018
4.2 TDI quattro	250/340	05/2009-08/2015	8DCT	TT01-95-021

Audi TT (8J3)



TT02-95-005



TT02-95-010



TT02-95-006



TT02-95-014



TT02-95-012

Diferencial delantero

Modelo	kW/HP	Año	Caja	Referencia
2.0 TDI quattro	125/170	06/2008-06/2014	6AT	TT02-95-014
2.0 TDI quattro	125/170	06/2008-06/2014	6MT	TT02-95-006
2.0 TFSI quattro	147/200	06/2008-06/2010	6MT	TT02-95-006
2.0 TFSI quattro	147/200	06/2008-06/2010	6AT	TT02-95-014
2.0 TFSI quattro	155/211	05/2010-06/2014	6MT	TT02-95-006
2.0 TFSI quattro	155/211	05/2010-06/2014	6AT	TT02-95-014
2.0 TTS quattro	195/265	05/2008-06/2014	6MT	TT02-95-006
2.0 TTS quattro	195/265	05/2008-06/2014	6AT	TT02-95-014
2.0 TTS quattro	200/272	05/2008-06/2014	6AT	TT02-95-014

Diferencial delantero

Modelo	kW/HP	Año	Caja	Referencia
2.0 TTS quattro	200/272	05/2008-06/2014	6MT	TT02-95-006
2.5 RS quattro	250/340	07/2009-06/2014	7AT	TT02-95-012
2.5 RS quattro	250/340	07/2009-06/2014	6MT	TT02-95-010
2.5 RS quattro	265/360	05/2011-06/2014	7AT	TT02-95-012
2.5 RS quattro	265/360	05/2011-06/2014	6MT	TT02-95-010
3.2 V6 quattro	184/250	08/2006-10/2006	6AT	TT02-95-005
3.2 V6 quattro	184/250	08/2006-06/2010	6MT	TT02-95-006
3.2 V6 quattro	184/250	11/2006-06/2010	6AT	TT02-95-014

Audi TT (8J3)



TT03-95-005



TT03-95-008



TT03-95-011

Diferencial trasero				
Modelo	kW/HP	Año	Caja	Referencia
2.0 TDI quattro	125/170	06/2008-06/2014	6AT	TT03-95-008
2.0 TDI quattro	125/170	06/2008-06/2014	6MT	TT03-95-008
2.0 TFSI quattro	147/200	06/2008-06/2010	6MT	TT03-95-008
2.0 TFSI quattro	147/200	06/2008-06/2010	6AT	TT03-95-008
2.0 TFSI quattro	155/211	05/2010-06/2014	6MT	TT03-95-008
2.0 TFSI quattro	155/211	05/2010-06/2014	6AT	TT03-95-008
2.0 TTS quattro	195/265	05/2008-06/2014	6AT	TT03-95-008
2.0 TTS quattro	195/265	05/2008-06/2014	6MT	TT03-95-008
2.0 TTS quattro	200/272	05/2008-06/2014	6MT	TT03-95-008

Diferencial trasero				
Modelo	kW/HP	Año	Caja	Referencia
2.0 TTS quattro	200/272	05/2008-06/2014	6AT	TT03-95-008
2.5 RS quattro	250/340	07/2009-06/2014	7AT	TT03-95-011
2.5 RS quattro	250/340	07/2009-06/2014	6MT	TT03-95-011
2.5 RS quattro	265/360	05/2011-06/2014	7AT	TT03-95-011
2.5 RS quattro	265/360	05/2011-06/2014	6MT	TT03-95-011
3.2 V6 quattro	184/250	08/2006-10/2009	6MT	TT03-95-005
3.2 V6 quattro	184/250	08/2006-06/2010	6AT	TT03-95-005
3.2 V6 quattro	184/250	11/2009-06/2010	6MT	TT03-95-008
3.2 V6 quattro	184/250	11/2009-06/2010	6AT	TT03-95-008

Audi TT (8N3)



TT02-95-004



TT03-95-016

Diferencial delantero				
Modelo	kW/HP	Año	Caja	Referencia
1.8 T quattro	132/180	10/1998-06/2006	6AT	TT02-95-004
1.8 T quattro	140/190	09/2005-06/2006	6AT	TT02-95-004
1.8 T quattro	176/240	03/2005-06/2006	6AT	TT02-95-004
3.2 VR6 quattro	184/250	07/2003-06/2006	6AT	TT02-95-004

Diferencial trasero				
Modelo	kW/HP	Año	Caja	Referencia
1.8 T quattro	132/180	10/1998-08/2002	5MT	TT03-95-016
1.8 T quattro	132/180	10/1998-06/2006	6MT	TT03-95-016
1.8 T quattro	132/180	10/1998-06/2006	6AT	TT03-95-016
1.8 T quattro	134/182	09/1999-08/2002	5MT	TT03-95-016
1.8 T quattro	134/182	09/1999-06/2006	6MT	TT03-95-016
1.8 T quattro	140/190	09/2005-06/2006	5MT	TT03-95-016
1.8 T quattro	140/190	09/2005-06/2006	6AT	TT03-95-016
1.8 T quattro	140/190	09/2005-06/2006	6MT	TT03-95-016
1.8 T quattro	165/224	10/1998-06/2006	6MT	TT03-95-016
1.8 T quattro	168/228	09/1999-06/2006	6MT	TT03-95-016
1.8 T quattro	176/240	03/2005-06/2006	6MT	TT03-95-016
1.8 T quattro	176/240	03/2005-06/2006	6AT	TT03-95-016
3.2 VR6 quattro	184/250	07/2003-06/2006	6AT	TT03-95-016
3.2 VR6 quattro	184/250	07/2003-06/2006	6MT	TT03-95-016

Audi TT Roadster (8J9)



TT02-95-010



TT02-95-006



TT02-95-014



TT02-95-012

Diferencial delantero

Modelo	kW/HP	Año	Caja	Referencia
2.0 TDI quattro	125/170	06/2008-06/2014	6AT	TT02-95-014
2.0 TDI quattro	125/170	06/2008-06/2014	6MT	TT02-95-006
2.0 TFSI quattro	147/200	06/2008-06/2010	6AT	TT02-95-014
2.0 TFSI quattro	155/211	05/2010-06/2014	6MT	TT02-95-006
2.0 TFSI quattro	155/211	05/2010-06/2014	6AT	TT02-95-014
2.0 TTS quattro	195/265	05/2008-06/2014	6MT	TT02-95-006
2.0 TTS quattro	195/265	05/2008-06/2014	6AT	TT02-95-014
2.0 TTS quattro	200/272	05/2008-06/2014	6AT	TT02-95-014
2.0 TTS quattro	200/272	05/2008-06/2014	6MT	TT02-95-006

Diferencial delantero

Modelo	kW/HP	Año	Caja	Referencia
2.5 RS quattro	250/340	07/2009-06/2014	7MT	TT02-95-012
2.5 RS quattro	250/340	07/2009-06/2014	7AT	TT02-95-012
2.5 RS quattro	250/340	07/2009-06/2014	6MT	TT02-95-010
2.5 RS quattro	265/360	03/2012-06/2014	7MT	TT02-95-012
2.5 RS quattro	265/360	03/2012-06/2014	6MT	TT02-95-010
2.5 RS quattro	265/360	03/2012-06/2014	7AT	TT02-95-012
3.2 V6 quattro	184/250	03/2007-06/2010	6AT	TT02-95-014
3.2 V6 quattro	184/250	03/2007-06/2010	6MT	TT02-95-006



TT03-95-011



TT03-95-007

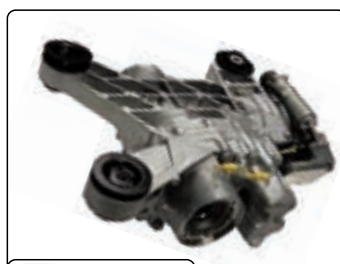

TT03-95-009

Diferencial trasero

Modelo	kW/HP	Año	Caja	Referencia
2.0 TDI quattro	125/170	06/2008-06/2014	6AT	TT03-95-009
2.0 TDI quattro	125/170	06/2008-06/2014	6MT	TT03-95-009
2.0 TFSI quattro	147/200	06/2008-06/2010	6AT	TT03-95-009
2.0 TFSI quattro	155/211	05/2010-06/2014	6AT	TT03-95-009
2.0 TFSI quattro	155/211	05/2010-06/2014	6MT	TT03-95-009
2.0 TTS quattro	195/265	05/2008-06/2014	6AT	TT03-95-009
2.0 TTS quattro	195/265	05/2008-06/2014	6MT	TT03-95-009
2.0 TTS quattro	200/272	05/2008-06/2014	6AT	TT03-95-009
2.0 TTS quattro	200/272	05/2008-06/2014	6MT	TT03-95-009
2.5 RS quattro	250/340	07/2009-06/2014	7MT	TT03-95-011

Diferencial trasero

Modelo	kW/HP	Año	Caja	Referencia
2.5 RS quattro	250/340	07/2009-06/2014	7AT	TT03-95-011
2.5 RS quattro	250/340	07/2009-06/2014	6MT	TT03-95-011
2.5 RS quattro	265/360	03/2012-06/2014	7AT	TT03-95-011
2.5 RS quattro	265/360	03/2012-06/2014	7MT	TT03-95-011
2.5 RS quattro	265/360	03/2012-06/2014	6MT	TT03-95-011
3.2 V6 quattro	184/250	03/2007-11/2009	6MT	TT03-95-007
3.2 V6 quattro	184/250	03/2007-11/2009	6AT	TT03-95-007
3.2 V6 quattro	184/250	11/2009-06/2010	6AT	TT03-95-009
3.2 V6 quattro	184/250	11/2009-06/2010	6MT	TT03-95-009

Audi TT Roadster (8N9)



TT02-95-004



TT03-95-016

Diferencial delantero

Modelo	kW/HP	Año	Caja	Referencia
1.8 T quattro	132/180	02/2000-06/2006	6AT	TT02-95-004
1.8 T quattro	140/190	09/2005-06/2006	6AT	TT02-95-004
3.2 VR6 quattro	184/250	07/2003-06/2006	6AT	TT02-95-004

Diferencial trasero

Modelo	kW/HP	Año	Caja	Referencia
1.8 T quattro	132/180	02/2000-08/2002	5MT	TT03-95-016
1.8 T quattro	132/180	02/2000-06/2006	6AT	TT03-95-016
1.8 T quattro	132/180	02/2000-06/2006	6MT	TT03-95-016
1.8 T quattro	134/182	10/1999-08/2002	5MT	TT03-95-016
1.8 T quattro	134/182	10/1999-08/2002	6MT	TT03-95-016
1.8 T quattro	140/190	09/2005-06/2006	6MT	TT03-95-016
1.8 T quattro	140/190	09/2005-06/2006	5MT	TT03-95-016
1.8 T quattro	140/190	09/2005-06/2006	6AT	TT03-95-016
1.8 T quattro	165/224	10/1999-06/2006	6MT	TT03-95-016
1.8 T quattro	168/228	09/2000-06/2006	6MT	TT03-95-016
3.2 VR6 quattro	184/250	07/2003-06/2006	6AT	TT03-95-016
3.2 VR6 quattro	184/250	07/2003-06/2006	6MT	TT03-95-016



CONTINENTAL Coupé (3W_, 393)

Imagen usada como referencia

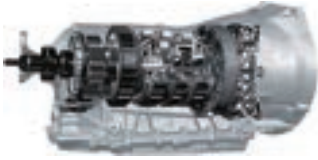

EST-1068032076800



Cajas de cambio automáticas 6 HP 26 A 61

Modelo	kW/HP	Año	Caja	Referencia
6.0 GT	412/560	06/2003-12/2011	6AT	EST-1068032076800
6.0 GT	412/560	06/2003-12/2011	6AT	EST-1068032135800
6.0 GT	412/560	06/2003-12/2011	6AT	EST-1068032211000
6.0 GT	412/560	06/2003-12/2011	6AT	EST-1068032245000

CONTINENTAL FLYING SPUR (3W_)

Imagen usada como referencia

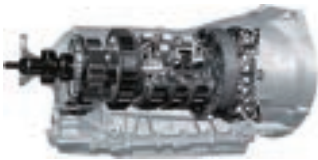

EST-1068032187800



Cajas de cambio automáticas 6 HP 26 A 61

Modelo	kW/HP	Año	Caja	Referencia
6.0	412/560	03/2005-12/2010	6AT	EST-1068032187800
6.0	412/560	03/2005-12/2010	6AT	EST-1068032213800
6.0 FLEX	449/610	09/2008-02/2013	6AT	EST-1068032248800

CONTINENTAL Descapotable (3W_, 394)

Imagen usada como referencia

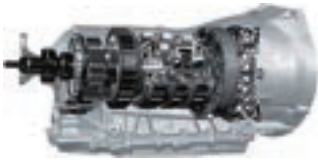

EST-1068032245000



Cajas de cambio automáticas 6 HP 26 A 61

Modelo	kW/HP	Año	Caja	Referencia
6.0 AWD	412/560	06/2006-04/2011	6AT	EST-1068032245000



BMW 1 (E81)



Cajas de cambio automáticas 6 HP 19				
Modelo	kW/HP	Año	Caja	Referencia
120 d	120/163	03/2007-12/2011	6AT	EST-1071012078800

Cajas de cambio automáticas 6 HP 21				
Modelo	kW/HP	Año	Caja	Referencia
116 i	90/122	03/2007-12/2011	6AT	EST-1071032145800
118 d	105/143	09/2006-12/2011	6AT	EST-1071032039800
120 d	130/177	03/2007-12/2011	6AT	EST-1071032039800
123 d	150/204	03/2007-12/2011	6AT	EST-1071032095000
123 d	150/204	03/2007-12/2011	6AT	EST-1071032141800

BMW 1 (F20)

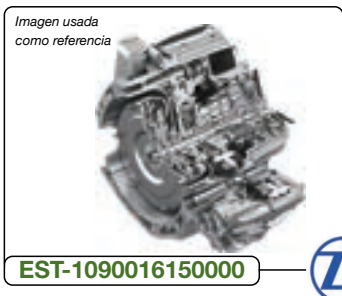

Cajas de cambio automáticas 8 HP 45 HIS, 8 marchas				
Modelo	kW/HP	Año	Caja	Referencia
116 i	100/136	07/2011-02/2015	8AT	EST-1090016150000
118 d	105/143	07/2011-02/2015	8AT	EST-1090016091000
118 d	105/143	07/2011-02/2015	8AT	EST-1090016147000
118 i	125/170	07/2011-02/2015	8AT	EST-1090016150000



Cajas de transfer				
Modelo	kW/HP	Año	Caja	Referencia
118 d xDrive	105/143	07/2013-07/2015		TT01-10-001
118 d xDrive	105/143	07/2015-		TT01-10-006
118 d xDrive	110/150	03/2015-07/2015		TT01-10-001
118 d xDrive	110/150	07/2015-		TT01-10-006
120 d xDrive	135/184	02/2012-07/2015		TT01-10-001
120 d xDrive	135/184	07/2015-		TT01-10-006
120 d xDrive	140/190	03/2015-07/2015		TT01-10-001
120 d xDrive	140/190	07/2015-		TT01-10-006
120 d xDrive	147/200	01/2011-07/2015		TT01-10-001
120 d xDrive	147/200	07/2015-		TT01-10-006
M 135 i xDrive	235/320	02/2012-07/2015		TT01-10-001
M 135 i xDrive	235/320	07/2015-		TT01-10-006
M 135 i xDrive	240/326	03/2015-07/2015		TT01-10-001
M 135 i xDrive	240/326	07/2015-		TT01-10-006



BMW 1 (F21)



TT01-10-006



TT01-10-001

Cajas de transfer

Modelo	kW/HP	Año	Caja	Referencia
118 d xDrive	105/143	05/2013-07/2015		TT01-10-001
118 d xDrive	105/143	07/2015-		TT01-10-006
118 d xDrive	110/150	03/2015-07/2015		TT01-10-001
118 d xDrive	110/150	07/2015-		TT01-10-006
120 d xDrive	135/184	02/2012-07/2015		TT01-10-001
120 d xDrive	135/184	07/2015-		TT01-10-006
120 d xDrive	140/190	03/2015-07/2015		TT01-10-001
120 d xDrive	140/190	07/2015-		TT01-10-006
120 d xDrive	147/200	01/2012-07/2015		TT01-10-001
120 d xDrive	147/200	07/2015-		TT01-10-006
M 135 i xDrive	235/320	02/2012-07/2015		TT01-10-001
M 135 i xDrive	235/320	07/2015-		TT01-10-006
M 135 i xDrive	240/326	03/2015-07/2015		TT01-10-001
M 135 i xDrive	240/326	07/2015-		TT01-10-006

BMW 1 Coupé (E82)

Imagen usada como referencia

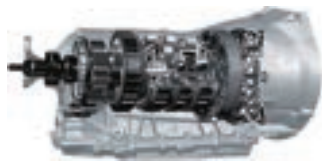

EST-1071032039800



Cajas de cambio automáticas 6 HP 21

Modelo	kW/HP	Año	Caja	Referencia
120 d	130/177	09/2007-10/2013	6AT	EST-1071032039800

BMW 2 Coupé (F22, F87)



TT01-10-006



TT01-10-001

Cajas de transfer

Modelo	kW/HP	Año	Caja	Referencia
220 d xDrive	120/163	03/2015-07/2015		TT01-10-001
220 d xDrive	120/163	07/2015-		TT01-10-006
220 d xDrive	140/190	03/2015-07/2015		TT01-10-001
220 d xDrive	140/190	07/2015-		TT01-10-006
228 i xDrive	180/245	07/2014-07/2015		TT01-10-001
228 i xDrive	180/245	07/2015-		TT01-10-006
230 i xDrive	185/252	09/2016-		TT01-10-001
M 235 i xDrive	240/326	07/2014-07/2015		TT01-10-001

BMW 2 Descapotable (F23)



TT01-10-006



TT01-10-001

Cajas de transfer

Modelo	kW/HP	Año	Caja	Referencia
M 235 i xDrive	240/326	07/2015-06/2016		TT01-10-006
M 240 i xDrive	250/340	09/2015-06/2021		TT01-10-001

BMW 3 (E90)

Imagen usada como referencia

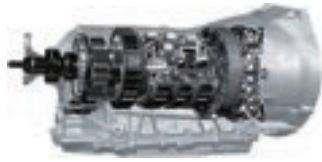

EST-1071012078800



Cajas de cambio automáticas 6 HP 19

Modelo	kW/HP	Año	Caja	Referencia
320 d	120/163	12/2004-10/2011	6AT	EST-1071012078800
320 i	110/150	12/2004-08/2007	6AT	EST-1071012073800
325 i	160/218	12/2004-12/2011	6AT	EST-1071012049800
325 i	160/218	12/2004-12/2011	6AT	EST-1071012085000
330 i	190/258	12/2004-10/2011	6AT	EST-1071012086800

Cajas de cambio automáticas 6 HP 19 X

Modelo	kW/HP	Año	Caja	Referencia
330 xi	190/258	09/2005-08/2007	6AT	EST-1071022015800

Cajas de cambio automáticas 6 HP 21

Modelo	kW/HP	Año	Caja	Referencia
318 d	105/143	02/2007-10/2011	6AT	EST-1071032183000
320 d	120/163	12/2004-10/2011	6AT	EST-1071032039800
320 d	130/177	09/2007-02/2010	6AT	EST-1071032160800
320 d	130/177	09/2007-02/2010	6AT	EST-1071032182000
320 i	125/170	09/2007-02/2011	6AT	EST-1071032179800
320 d	135/184	03/2010-10/2011	6AT	EST-1071032184000
325 d	145/197	09/2006-02/2010	6AT	EST-1071032040800
325 d	145/197	09/2006-02/2010	6AT	EST-1071032144800
325 i	160/218	12/2004-11/2011	6AT	EST-1071032135000
335 i	225/306	09/2006-12/2011	6AT	EST-1071032019800
335 i	225/306	09/2006-12/2011	6AT	EST-1071032131800
330 i	200/272	09/2007-10/2011	6AT	EST-1071032133800

Cajas de cambio automáticas 6 HP 21 X

Modelo	kW/HP	Año	Caja	Referencia
320 d xDrive	130/177	09/2008-02/2010	6AT	EST-1071052074800
320 d xDrive	130/177	09/2008-02/2010	6AT	EST-1071052087800
335 xi	225/306	03/2007-08/2008	6AT	EST-1071052061800

Cajas de cambio automáticas 6 HP 26

Modelo	kW/HP	Año	Caja	Referencia
330 d	170/231	09/2005-09/2008	6AT	EST-1068012404800

Cajas de cambio automáticas 6 HP 26 X

Modelo	kW/HP	Año	Caja	Referencia
330 xd	170/231	09/2005-08/2008	6AT	EST-1068022105800

Cajas de cambio automáticas 6 HP 28

Modelo	kW/HP	Año	Caja	Referencia
330 d	170/231	09/2005-09/2008	6AT	EST-1068042024000
330 d	170/231	09/2005-09/2008	6AT	EST-1068042078000
330 d	180/245	09/2008-10/2011	6AT	EST-1068042142800
335 d	210/286	09/2006-12/2011	6AT	EST-1068042009800
335 d	210/286	09/2006-12/2011	6AT	EST-1068042072800
335 d	210/286	09/2006-12/2011	6AT	EST-1068042141800

Cajas de cambio automáticas 6 HP 28 X

Modelo	kW/HP	Año	Caja	Referencia
330 xd	170/231	09/2005-08/2008	6AT	EST-1068052028800
330 xd	170/231	09/2005-08/2008	6AT	EST-1068052083800

BMW 3 (E90)



TT01-10-017



TT01-10-018

Cajas de transfer

Modelo	kW/HP	Año	Caja	Referencia
320 d xDrive	120/163	07/2008-12/2011		TT01-10-017
320 d xDrive	130/177	09/2008-12/2011		TT01-10-017
320 d xDrive	135/184	01/2010-12/2011		TT01-10-018
320 xd	130/177	09/2007-12/2011		TT01-10-017
325 i xDrive	160/218	06/2008-10/2011		TT01-10-017
325 xi	160/218	01/2005-12/2011		TT01-10-017
328 i xDrive	171/234	09/2008-12/2010		TT01-10-017
328 xi	171/234	09/2006-12/2008		TT01-10-017
330 d xDrive	180/245	01/2009-12/2011		TT01-10-017

Cajas de transfer

Modelo	kW/HP	Año	Caja	Referencia
330 i xDrive	200/272	09/2008-12/2011		TT01-10-017
330 xd	170/231	09/2005-12/2011		TT01-10-017
330 xi	190/258	01/2005-08/2007		TT01-10-017
330 xi	200/272	09/2007-12/2011		TT01-10-017
335 i xDrive	224/305	09/2008-12/2011		TT01-10-017
335 i xDrive	225/306	09/2008-12/2011		TT01-10-017
335 xi	224/305	09/2006-12/2008		TT01-10-017
335 xi	225/306	09/2007-12/2011		TT01-10-017

BMW 3 (F30, F80)

Imagen usada como referencia



EST-1090016091000



Cajas de cambio automáticas 8 HP 45 HIS, 8 marchas

Modelo	kW/HP	Año	Caja	Referencia
318 d	105/143	03/2012-06/2015	8AT	EST-1090016091000
318 d	105/143	03/2012-06/2015	8AT	EST-1090016147000
320 d	135/184	11/2011-03/2016	8AT	EST-1090016090000
320 d	135/184	11/2011-03/2016	8AT	EST-1090016146000
328 i	180/245	11/2011-10/2018	8AT	EST-1090016148000
328 i	180/245	11/2011-10/2018	8AT	EST-1090016163000
335 i	225/306	11/2011-07/2015	8AT	EST-1090016141800



TT01-10-006



TT01-10-001

Cajas de transfer

Modelo	kW/HP	Año	Caja	Referencia
318 d xDrive	105/143	11/2012-07/2015		TT01-10-006
318 d xDrive	105/143	07/2015-		TT01-10-001
318 d xDrive	110/150	07/2015-		TT01-10-001
320 d xDrive	120/163	05/2012-07/2015		TT01-10-006
320 d xDrive	120/163	07/2015-		TT01-10-001
320 d xDrive	135/184	10/2011-07/2015		TT01-10-006
320 d xDrive	140/190	07/2015-		TT01-10-001
320 d xDrive	147/200	05/2012-07/2015		TT01-10-006

Cajas de transfer

Modelo	kW/HP	Año	Caja	Referencia
320 d xDrive	147/200	07/2015-		TT01-10-001
320 i xDrive	134/182	09/2012-07/2015		TT01-10-006
320 i xDrive	134/182	07/2015-		TT01-10-001
320 i xDrive	135/184	11/2011-07/2015		TT01-10-006
320 i xDrive	135/184	07/2015-		TT01-10-001
328 i xDrive	180/245	10/2011-07/2015		TT01-10-006
328 i xDrive	180/245	07/2015-		TT01-10-001
330 d xDrive	190/258	03/2013-07/2015		TT01-10-006
330 d xDrive	190/258	07/2015-		TT01-10-001
330 d xDrive	210/286	09/2015-		TT01-10-001
330 i xDrive	185/252	07/2015-		TT01-10-001
335 d xDrive	230/313	07/2013-07/2015		TT01-10-006
335 d xDrive	230/313	07/2015-		TT01-10-001
335 i xDrive	225/306	07/2015-		TT01-10-001
335 i xDrive	250/340	07/2015-		TT01-10-001
340 i xDrive	240/326	07/2015-		TT01-10-001
340 i xDrive	265/360	10/2015-		TT01-10-001

BMW 3 (G20, G80, G28)



TT01-10-003

Cajas de transfer

Modelo	kW/HP	Año	Caja	Referencia
320 d xDrive	120/163	11/2018-02/2020		TT01-10-003
320 d xDrive	140/190	11/2018-02/2020		TT01-10-003
330 i xDrive	190/258	11/2018-		TT01-10-003

BMW 3 Coupé (E92)

Imagen usada como referencia

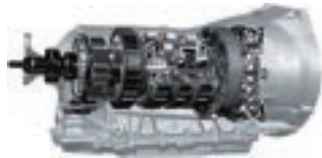

EST-1071032039800



Cajas de cambio automáticas 6 HP 21

Modelo	kW/HP	Año	Caja	Referencia
320 d	130/177	09/2006-02/2010	6AT	EST-1071032039800
320 d	130/177	09/2006-02/2010	6AT	EST-1071032182000
320 d	135/184	03/2010-06/2013	6AT	EST-1071032184000
320 d xDrive	130/177	09/2008-02/2010	6AT	EST-1071052087800
325 d	145/197	02/2007-02/2010	6AT	EST-1071032040800
325 i	160/218	06/2006-02/2010	6AT	EST-1071032021000
335 i	225/306	06/2006-06/2013	6AT	EST-1071032019800

Cajas de cambio automáticas 6 HP 28

Modelo	kW/HP	Año	Caja	Referencia
330 d	170/231	03/2006-08/2008	6AT	EST-1068042010800
335 d	210/286	03/2006-03/2013	6AT	EST-1068042009800



TT01-10-017



Cajas de transfer

Modelo	kW/HP	Año	Caja	Referencia
320 d xDrive	130/177	09/2008-12/2013		TT01-10-017
320 d xDrive	135/184	01/2010-12/2013		TT01-10-017
320 xd	130/177	03/2007-12/2013		TT01-10-017
325 i xDrive	150/204	09/2006-12/2013		TT01-10-017
325 i xDrive	160/218	09/2008-12/2013		TT01-10-017
325 xi	160/218	09/2006-12/2013		TT01-10-017
328 i xDrive	171/233	09/2009-12/2013		TT01-10-017
328 xi	171/233	09/2006-12/2007		TT01-10-017

Cajas de transfer

Modelo	kW/HP	Año	Caja	Referencia
330 d xDrive	180/245	01/2009-12/2013		TT01-10-017
330 i xDrive	200/272	09/2008-12/2013		TT01-10-017
330 xd	170/231	09/2006-12/2013		TT01-10-017
330 xd	180/245	01/2009-12/2013		TT01-10-017
330 xi	190/258	09/2006-12/2013		TT01-10-017
330 xi	200/272	09/2006-12/2013		TT01-10-017
335 i xDrive	225/306	09/2008-12/2013		TT01-10-017
335 xi	225/306	09/2006-12/2013		TT01-10-017

BMW 3 Descapotable (E93)

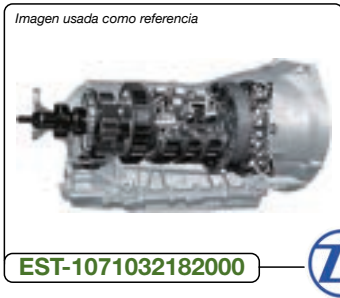

Cajas de cambio automáticas 6 HP 21				
Modelo	kW/HP	Año	Caja	Referencia
320 d	130/177	03/2008-02/2010	6AT	EST-1071032182000
320 d	135/184	03/2010-10/2013	6AT	EST-1071032184000
325 d	145/197	03/2007-12/2010	6AT	EST-1071032040800

BMW 3 Gran Turismo (F34)



Cajas de transfer				
Modelo	kW/HP	Año	Caja	Referencia
320 d xDrive	120/163	03/2013-07/2015		TT01-10-006
320 d xDrive	120/163	07/2015-		TT01-10-001
320 d xDrive	135/184	03/2013-07/2015		TT01-10-006
320 d xDrive	140/190	07/2015-		TT01-10-001
320 d xDrive	140/190	07/2015-		TT01-10-006
320 d xDrive	147/200	05/2013-07/2015		TT01-10-006
320 d xDrive	147/200	07/2015-		TT01-10-001
320 i xDrive	120/163	03/2013-07/2015		TT01-10-006
320 i xDrive	120/163	07/2015-		TT01-10-001
320 i xDrive	135/184	03/2013-07/2015		TT01-10-006
320 i xDrive	135/184	07/2015-		TT01-10-001

Cajas de transfer				
Modelo	kW/HP	Año	Caja	Referencia
328 i xDrive	180/245	03/2013-07/2015		TT01-10-006
328 i xDrive	180/245	07/2015-		TT01-10-001
330 d xDrive	190/258	01/2014-07/2015		TT01-10-006
330 d xDrive	190/258	07/2015-		TT01-10-001
330 d xDrive	210/286	01/2014-07/2015		TT01-10-006
330 d xDrive	210/286	07/2015-		TT01-10-001
330 i xDrive	185/252	10/2015-		TT01-10-001
335 d xDrive	230/313	01/2014-07/2015		TT01-10-006
335 d xDrive	230/313	07/2015-		TT01-10-001
340 i xDrive	240/326	10/2015-		TT01-10-001

BMW 3 Touring (E91)



Cajas de cambio automáticas 6 HP 19				
Modelo	kW/HP	Año	Caja	Referencia
320 i	110/150	09/2005-06/2012	6AT	EST-1071012073800
325 i	160/218	12/2004-08/2008	6AT	EST-1071012049800
325 i	160/218	12/2004-08/2008	6AT	EST-1071012085000
330 i	190/258	08/2005-08/2007	6AT	EST-1071012086800
320 d	120/163	06/2005-06/2012	6AT	EST-1071012078800

Cajas de cambio automáticas 6 HP 19 X				
Modelo	kW/HP	Año	Caja	Referencia
330 xi	190/258	09/2005-08/2007	6AT	EST-1071022015800

BMW 3 Touring (E91)

Imagen usada como referencia

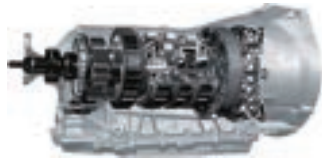

EST-1071012073800



Cajas de cambio automáticas 6 HP 21

Modelo	kW/HP	Año	Caja	Referencia
320 d	120/163	06/2005-06/2012	6AT	EST-1071032039800
335 i	225/306	09/2006-06/2012	6AT	EST-1071032019800
325 d	145/197	09/2006-06/2012	6AT	EST-1071032040800
318 d	105/143	09/2007-06/2012	6AT	EST-1071032183000
320 d	130/177	02/2007-12/2010	6AT	EST-1071032182000
320 d	135/184	03/2010-05/2012	6AT	EST-1071032184000

Cajas de cambio automáticas 6 HP 21 X

Modelo	kW/HP	Año	Caja	Referencia
320 d xDrive	130/177	09/2008-02/2010	6AT	EST-1071052087800

Cajas de cambio automáticas 6 HP 26

Modelo	kW/HP	Año	Caja	Referencia
330 d	170/231	12/2004-08/2008	6AT	EST-1068012404800

Cajas de cambio automáticas 6 HP 26 X

Modelo	kW/HP	Año	Caja	Referencia
330 xd	170/231	09/2005-06/2012	6AT	EST-1068022105800

Cajas de cambio automáticas 6 HP 28

Modelo	kW/HP	Año	Caja	Referencia
335 d	210/286	09/2006-06/2012	6AT	EST-1068042009800



TT01-10-017

Cajas de transfer

Modelo	kW/HP	Año	Caja	Referencia
320 d xDrive	120/163	07/2009-06/2012		TT01-10-017
320 d xDrive	130/177	09/2008-06/2012		TT01-10-017
320 d xDrive	135/184	01/2010-06/2012		TT01-10-017
325 i xDrive	160/218	09/2007-06/2012		TT01-10-017
325 xi	160/218	09/2005-06/2012		TT01-10-017
328 i xDrive	171/234	09/2008-12/2010		TT01-10-017
328 xi	171/234	09/2006-12/2008		TT01-10-017

Cajas de transfer

Modelo	kW/HP	Año	Caja	Referencia
330 d xDrive	180/245	01/2009-06/2012		TT01-10-017
330 i xDrive	200/272	09/2007-06/2012		TT01-10-017
330 xd	170/231	09/2005-06/2012		TT01-10-017
330 xi	190/258	09/2005-08/2007		TT01-10-017
330 xi	200/272	09/2007-06/2012		TT01-10-017
335 i xDrive	225/306	09/2008-06/2012		TT01-10-017
335 i xDrive	240/326	09/2006-06/2012		TT01-10-017
335 xi	225/306	03/2007-06/2012		TT01-10-017

BMW 3 Touring (F31)

Imagen usada como referencia



EST-1090016091000



Cajas de cambio automáticas 8 HP 45 HIS, 8 marchas

Modelo	kW/HP	Año	Caja	Referencia
318 d	105/143	11/2012-06/2015	8AT	EST-1090016091000
318 d	105/143	11/2012-06/2015	8AT	EST-1090016147000
320 d	135/184	07/2012-02/2016	8AT	EST-1090016090000
320 d	135/184	07/2012-02/2016	8AT	EST-1090016146000

BMW 3 Touring (F31)



TT01-10-006



TT01-10-001

Cajas de transfer

Modelo	kW/HP	Año	Caja	Referencia
318 d xDrive	105/143	01/2013-07/2015		TT01-10-006
318 d xDrive	105/143	07/2015-		TT01-10-001
318 d xDrive	110/150	07/2015-		TT01-10-001
320 d xDrive	120/163	06/2012-07/2015		TT01-10-006
320 d xDrive	120/163	07/2015-		TT01-10-001
320 d xDrive	135/184	06/2012-07/2015		TT01-10-006
320 d xDrive	140/190	07/2015-		TT01-10-001
320 d xDrive	147/200	01/2013-07/2015		TT01-10-006
320 d xDrive	147/200	07/2015-		TT01-10-001
320 i xDrive	135/184	06/2012-07/2015		TT01-10-006
320 i xDrive	135/184	07/2015-		TT01-10-001
328 i xDrive	180/245	06/2012-07/2015		TT01-10-006
328 i xDrive	180/245	07/2015-		TT01-10-001

Cajas de transfer

Modelo	kW/HP	Año	Caja	Referencia
330 d xDrive	190/258	06/2012-07/2015		TT01-10-006
330 d xDrive	190/258	07/2015-		TT01-10-001
330 d xDrive	210/286	09/2015-		TT01-10-001
330 i xDrive	185/252	07/2015-		TT01-10-001
335 d xDrive	230/313	09/2013-07/2015		TT01-10-006
335 d xDrive	230/313	07/2015-		TT01-10-001
335 i xDrive	225/306	03/2013-07/2015		TT01-10-006
335 i xDrive	225/306	07/2015-		TT01-10-001
335 i xDrive	240/326	01/2012-07/2013		TT01-10-006
335 i xDrive	250/340	07/2013-07/2015		TT01-10-006
335 i xDrive	250/340	07/2015-		TT01-10-001
340 i xDrive	240/326	07/2015-		TT01-10-001
340 i xDrive	265/360	07/2015-		TT01-10-001

BMW 3 Touring (G21, G81)



TT01-10-003

Cajas de transfer

Modelo	kW/HP	Año	Caja	Referencia
320 d xDrive	120/163	07/2019-02/2020		TT01-10-003
320 d xDrive	140/190	07/2019-02/2020		TT01-10-003
330 i xDrive	190/258	07/2019-		TT01-10-003
M 340 i xDrive	275/374	11/2019-		TT01-10-003
M 340 i xDrive	285/387	11/2019-		TT01-10-003

BMW 3 (G21) Touring Van



TT01-10-003

Cajas de transfer

Modelo	kW/HP	Año	Caja	Referencia
330 d xDrive	195/265	11/2019-		TT01-10-003
M 340 i xDrive	275/374	11/2019-		TT01-10-003

BMW 4 Coupé (F32, F82)



TT01-10-006



TT01-10-001

Cajas de transfer

Modelo	kW/HP	Año	Caja	Referencia
420 d xDrive	120/163	11/2013-07/2015		TT01-10-006
420 d xDrive	120/163	07/2015-		TT01-10-001
420 d xDrive	135/184	11/2013-03/2015		TT01-10-006
420 d xDrive	140/190	03/2015-07/2015		TT01-10-006
420 d xDrive	140/190	07/2015-		TT01-10-001
420 d xDrive	147/200	11/2013-03/2015		TT01-10-006
420 i xDrive	120/163	11/2013-07/2015		TT01-10-006
420 i xDrive	120/163	07/2015-		TT01-10-001
420 i xDrive	135/184	11/2013-07/2015		TT01-10-006
420 i xDrive	135/184	07/2015-		TT01-10-001
428 i xDrive	180/245	07/2013-07/2015		TT01-10-006

Cajas de transfer

Modelo	kW/HP	Año	Caja	Referencia
428 i xDrive	180/245	07/2015-		TT01-10-001
430 d xDrive	190/258	01/2014-07/2015		TT01-10-006
430 d xDrive	210/286	11/2013-07/2015		TT01-10-006
430 i xDrive	185/252	03/2016-		TT01-10-001
435 d xDrive	230/313	11/2013-07/2015		TT01-10-006
435 i xDrive	225/306	07/2013-07/2015		TT01-10-006
435 i xDrive	250/340	07/2013-07/2015		TT01-10-006
435 i xDrive	250/340	07/2015-		TT01-10-001
440 i xDrive	240/326	03/2016-		TT01-10-001
440 i xDrive	265/360	03/2016-		TT01-10-001

BMW 4 Descapotable (F33, F83)



TT01-10-006



TT01-10-001

Cajas de transfer

Modelo	kW/HP	Año	Caja	Referencia
428 i xDrive	180/245	01/2014-07/2015		TT01-10-006
428 i xDrive	180/245	07/2015-		TT01-10-001
430 i xDrive	185/252	03/2016-		TT01-10-001
435 d xDrive	230/313	07/2014-07/2015		TT01-10-006
435 d xDrive	230/313	07/2015-		TT01-10-001
435 i xDrive	225/306	07/2014-07/2015		TT01-10-006
435 i xDrive	225/306	07/2015-		TT01-10-001
435 i xDrive	250/340	07/2014-07/2015		TT01-10-006
435 i xDrive	250/340	07/2015-		TT01-10-001
440 i xDrive	240/326	03/2016-		TT01-10-001
440 i xDrive	265/360	03/2016-		TT01-10-001



BMW 4 Gran Coupe (F36)



TT01-10-006



TT01-10-001

Cajas de transfer

Modelo	kW/HP	Año	Caja	Referencia
420 d xDrive	120/163	03/2014-07/2015		TT01-10-006
420 d xDrive	120/163	03/2015-		TT01-10-001
420 d xDrive	135/184	03/2014-03/2015		TT01-10-006
420 d xDrive	140/190	03/2015-07/2015		TT01-10-006
420 d xDrive	140/190	07/2015-		TT01-10-001
420 d xDrive	147/200	03/2014-03/2015		TT01-10-006
420 i xDrive	120/163	03/2014-07/2015		TT01-10-006
420 i xDrive	120/163	03/2015-		TT01-10-001
420 i xDrive	135/184	07/2014-07/2015		TT01-10-006
420 i xDrive	135/184	07/2015-		TT01-10-001
428 i xDrive	180/245	03/2014-07/2015		TT01-10-006
428 i xDrive	180/245	03/2015-		TT01-10-001

Cajas de transfer

Modelo	kW/HP	Año	Caja	Referencia
430 d xDrive	190/258	07/2014-07/2015		TT01-10-006
430 d xDrive	190/258	07/2015-		TT01-10-001
430 d xDrive	210/286	07/2014-07/2015		TT01-10-006
430 d xDrive	210/286	07/2015-		TT01-10-001
430 i xDrive	185/252	03/2016-		TT01-10-001
435 d xDrive	230/313	07/2014-07/2015		TT01-10-006
435 d xDrive	230/313	07/2015-		TT01-10-001
435 i xDrive	225/306	07/2014-07/2015		TT01-10-006
435 i xDrive	250/340	07/2014-07/2015		TT01-10-006
440 i xDrive	240/326	03/2016-		TT01-10-001
440 i xDrive	265/360	03/2016-		TT01-10-001

BMW 5 (E60)

Imagen usada como referencia

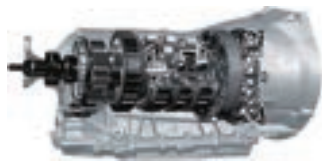

EST-1071012078800



Cajas de cambio automáticas 6 HP 19

Modelo	kW/HP	Año	Caja	Referencia
520 d	120/163	09/2005-12/2009	6AT	EST-1071012078800
520 i	125/170	07/2003-03/2010	6AT	EST-1071012048800
523 i	130/177	10/2004-02/2007	6AT	EST-1071012049800
523 i	130/177	10/2004-02/2007	6AT	EST-1071012085000
525 i	160/218	03/2005-12/2009	6AT	EST-1071012049800
525 i	160/218	03/2005-12/2009	6AT	EST-1071012085000
530 i	170/231	12/2001-02/2005	6AT	EST-1071012050800
530 i	190/258	03/2005-03/2007	6AT	EST-1071012086800

Cajas de cambio automáticas 6 HP 19 X

Modelo	kW/HP	Año	Caja	Referencia
530 xi	190/258	09/2004-02/2007	6AT	EST-1071022015800

Cajas de cambio automáticas 6 HP 21

Modelo	kW/HP	Año	Caja	Referencia
520 d	120/163	09/2005-12/2009	6AT	EST-1071032093000
520 d	130/177	09/2007-12/2009	6AT	EST-1071032143800
520 i	125/170	09/2007-12/2009	6AT	EST-1071032138800
525 d	145/197	01/2007-03/2010	6AT	EST-1071032140800
525 i	160/218	01/2007-03/2010	6AT	EST-1071032136000
530 d	173/235	02/2007-12/2009	6AT	EST-1071032094000
530 i	200/272	03/2007-12/2009	6AT	EST-1071032134000

BMW 5 (E60)

Imagen usada como referencia

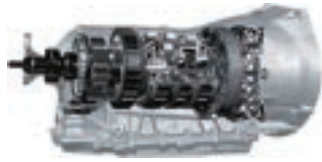

EST-1071052070800



Cajas de cambio automáticas 6 HP 21 X

Modelo	kW/HP	Año	Caja	Referencia
525 xd	145/197	09/2007-08/2008	6AT	EST-1071052070800
525 xi	160/218	03/2007-12/2009	6AT	EST-1071052068000
530 xd	173/235	03/2007-08/2007	6AT	EST-1071052048800
530 xi	200/272	02/2007-08/2008	6AT	EST-1071052066800
525 xd	145/197	09/2007-08/2008	6AT	EST-1071052070800

Cajas de cambio automáticas 6 HP 26

Modelo	kW/HP	Año	Caja	Referencia
525 d	130/177	06/2004-03/2010	6AT	EST-1068012244800
525 d	130/177	06/2004-03/2010	6AT	EST-1068012308800
525 d	130/177	06/2004-03/2010	6AT	EST-1068012367800
525 d	120/163	12/2004-03/2010	6AT	EST-1068012402800
530 d	170/231	09/2005-03/2007	6AT	EST-1068012176800
530 d	170/231	09/2005-03/2007	6AT	EST-1068012367800
530 d	170/231	09/2005-03/2007	6AT	EST-1068012403800
535 d	200/272	09/2004-03/2010	6AT	EST-1068012312800
535 d	200/272	09/2004-03/2010	6AT	EST-1068012359800
535 d	200/272	09/2004-03/2010	6AT	EST-1068012399800
540 i	225/306	03/2007-12/2009	6AT	EST-1068012401800
545 i	245/333	07/2003-08/2005	6AT	EST-1068012173800
545 i	245/333	07/2003-08/2005	6AT	EST-1068012253800
545 i	245/333	07/2003-08/2005	6AT	EST-1068012366800
550 i	270/367	09/2005-12/2009	6AT	EST-1068012400800

Cajas de cambio automáticas 6 HP 26 X

Modelo	kW/HP	Año	Caja	Referencia
530 xd	170/231	02/2005-02/2007	6AT	EST-1068022105800

Cajas de cambio automáticas 6 HP 28

Modelo	kW/HP	Año	Caja	Referencia
530 d	170/231	09/2005-03/2007	6AT	EST-1068042047000
530 d	173/235	02/2007-12/2009	6AT	EST-1068042075800
530 d	173/235	02/2007-12/2009	6AT	EST-1068042079800
535 d	210/286	01/2007-03/2010	6AT	EST-1068042058000
535 d	210/286	01/2007-03/2010	6AT	EST-1068042073800

Cajas de cambio automáticas 6 HP 28 X

Modelo	kW/HP	Año	Caja	Referencia
530 xd	173/235	03/2007-08/2007	6AT	EST-1068052082800



TT01-10-017

Cajas de transfer

Modelo	kW/HP	Año	Caja	Referencia
525 d xDrive	145/197	09/2008-03/2010		TT01-10-017
525 i xDrive	160/218	09/2008-03/2010		TT01-10-017
525 xd	145/197	01/2007-03/2010		TT01-10-017
525 xi	160/218	07/2005-03/2010		TT01-10-017
528 i xDrive	171/233	09/2007-03/2010		TT01-10-017
530 d xDrive	173/235	09/2008-03/2010		TT01-10-017
530 i xDrive	200/272	09/2008-03/2010		TT01-10-017

Cajas de transfer

Modelo	kW/HP	Año	Caja	Referencia
530 xd	170/231	07/2005-03/2010		TT01-10-017
530 xd	173/235	01/2007-03/2010		TT01-10-017
530 xi	190/258	07/2005-03/2010		TT01-10-017
530 x	200/272	01/2007-03/2010		TT01-10-017
535 i xDrive	224/305	09/2008-03/2010		TT01-10-017
535 ix	224/305	09/2008-12/2009		TT01-10-017

BMW 5 (F10)

Imagen usada
como referencia



EST-1071012078800



Cajas de cambio automáticas 8 HP 45 HIS, 8 marchas

Modelo	kW/HP	Año	Caja	Referencia
520 i	135/184	09/2011-10/2016	8AT	EST-1090016092000
520 i	135/184	09/2011-10/2016	8AT	EST-1090016109000
528 i	180/245	09/2011-10/2016	8AT	EST-1090016092000
528 i	180/245	09/2011-10/2016	8AT	EST-1090016109000
535 i	225/306	01/2010-10/2016	8AT	EST-1090016113000
520 d	135/184	06/2010-06/2014	8AT	EST-1090016145000

Cajas de cambio automáticas 8 HP 70, 8 marchas

Modelo	kW/HP	Año	Caja	Referencia
550 i	300/408	03/2010-06/2013	8AT	EST-1087012050000
550 i	300/408	03/2010-06/2013	8AT	EST-1087012073000

Cajas de cambio automáticas 8 HP 70 X HIS, 8 marchas

Modelo	kW/HP	Año	Caja	Referencia
530 d xDrive	190/258	03/2011-10/2016	8AT	EST-1087026030800
530 d xDrive	190/258	03/2011-10/2016	8AT	EST-1087026055800
535 d xDrive	230/313	09/2011-10/2016	8AT	EST-1087026047800
535 d xDrive	230/313	09/2011-10/2016	8AT	EST-1087026061000



TT01-10-002



TT01-10-006



TT01-10-001

Cajas de transfer

Modelo	kW/HP	Año	Caja	Referencia
520 d xDrive	120/163	02/2013-		TT01-10-006
520 d xDrive	135/184	02/2013-		TT01-10-006
520 d xDrive	140/190	07/2014-		TT01-10-001
525 d xDrive	155/211	09/2011-		TT01-10-006
525 d xDrive	160/218	09/2011-		TT01-10-006
528 i xDrive	180/245	09/2011-		TT01-10-006
530 d xDrive	190/258	09/2011-		TT01-10-001
530 d xDrive	210/286	10/2015-		TT01-10-001
535 d xDrive	230/313	09/2011-		TT01-10-001
535 i xDrive	225/306	03/2011-09/2011		TT01-10-002
535 i xDrive	225/306	09/2011-		TT01-10-001
535 i xDrive	240/326	07/2013-		TT01-10-001
550 i xDrive	298/405	09/2012-		TT01-10-001
550 i xDrive	300/408	08/2010-09/2011		TT01-10-002
550 i xDrive	300/408	09/2011-		TT01-10-001
550 i xDrive	330/449	05/2013-		TT01-10-001
550 i xDrive	332/452	07/2013-		TT01-10-001
M 550 d xDrive	280/381	01/2012-		TT01-10-001

BMW 5 (G30, F90)



TT01-10-003

Cajas de transfer				
Modelo	kW/HP	Año	Caja	Referencia
520 d xDrive	120/163	09/2016-		TT01-10-003
520 d xDrive	140/190	09/2016-		TT01-10-003
530 d xDrive	183/249	09/2016-06/2020		TT01-10-003
530 d xDrive	195/265	09/2016-06/2020		TT01-10-003
530 i xDrive	185/252	09/2016-12/2022		TT01-10-003
540 d xDrive	235/320	07/2017-06/2020		TT01-10-003

Cajas de transfer				
Modelo	kW/HP	Año	Caja	Referencia
540 i xDrive	250/340	09/2016-12/2022		TT01-10-003
540 i xDrive	265/360	09/2016-06/2020		TT01-10-003
M 550 d xDrive	294/400	06/2017-		TT01-10-003
M 550 i xDrive	340/462	03/2017-06/2019		TT01-10-003
M 550 i xDrive	390/530	07/2019-		TT01-10-003

BMW 5 (F10)

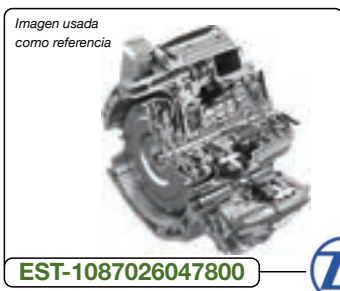

EST-1087026047800



Cajas de cambio automáticas 8 HP 45 HIS, 8 marchas				
Modelo	kW/HP	Año	Caja	Referencia
535 d xDrive	220/299	03/2010-06/2012	6AT	EST-1087026047800
550 i	300/408	08/2009-06/2012	6AT	EST-1087012050000
550 i	300/408	08/2009-06/2012	6AT	EST-1087012073000



TT01-10-002



TT01-10-001

Cajas de transfer				
Modelo	kW/HP	Año	Caja	Referencia
530 d xDrive	180/245	09/2010-05/2012		TT01-10-002
530 d xDrive	180/245	06/2012-		TT01-10-001
530 d xDrive	190/258	10/2009-05/2012		TT01-10-002
530 d xDrive	190/258	06/2012-		TT01-10-001
535 d xDrive	220/299	09/2010-05/2012		TT01-10-002
535 d xDrive	220/299	06/2012-		TT01-10-001
535 d xDrive	230/313	06/2012-		TT01-10-001

Cajas de transfer				
Modelo	kW/HP	Año	Caja	Referencia
535 i xDrive	225/306	09/2010-05/2012		TT01-10-002
535 i xDrive	225/306	06/2012-		TT01-10-001
550 i xDrive	298/405	09/2010-06/2012		TT01-10-002
550 i xDrive	300/408	04/2009-06/2012		TT01-10-002
550 i xDrive	300/408	06/2012-		TT01-10-001
550 i xDrive	330/449	04/2011-05/2012		TT01-10-002
550 i xDrive	330/449	06/2012-		TT01-10-001

BMW 5 Touring (E61)

Imagen usada como referencia

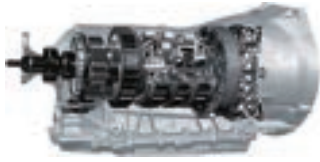

EST-1071012078800



Cajas de cambio automáticas 6 HP 19				
Modelo	kW/HP	Año	Caja	Referencia
520 d	120/163	04/2005-05/2010	6AT	EST-1071012078800
523 i	130/177	10/2004-02/2007	6AT	EST-1071012049800
523 i	130/177	10/2004-02/2007	6AT	EST-1071012085000
525 i	141/192	06/2004-12/2010	6AT	EST-1071012085000
525 i	160/218	03/2005-05/2010	6AT	EST-1071012049800
530 i	190/258	09/2004-02/2007	6AT	EST-1071012086800

Cajas de cambio automáticas 6 HP 19 X				
Modelo	kW/HP	Año	Caja	Referencia
530 xi	190/258	04/2005-02/2007	6AT	EST-1071022015800

Cajas de cambio automáticas 6 HP 21 X				
Modelo	kW/HP	Año	Caja	Referencia
530 xd	173/235	03/2007-08/2007	6AT	EST-1071052048800

Cajas de cambio automáticas 6 HP 26				
Modelo	kW/HP	Año	Caja	Referencia
525 d	130/177	03/2004-03/2007	6AT	EST-1068012244800
525 d	130/177	03/2004-03/2007	6AT	EST-1068012308800
525 d	130/177	03/2004-03/2007	6AT	EST-1068012367800
530 d	170/231	02/2005-02/2007	6AT	EST-1068012367800
530 d	170/231	02/2005-02/2007	6AT	EST-1068012403800
535 d	200/272	09/2004-12/2010	6AT	EST-1068012359800
535 d	200/272	09/2004-12/2010	6AT	EST-1068012399800
545 i	245/333	06/2004-12/2010	6AT	EST-1068012253800
550 i	270/367	07/2005-12/2010	6AT	EST-1068012400800

Cajas de cambio automáticas 6 HP 26 X				
Modelo	kW/HP	Año	Caja	Referencia
530 xd	170/231	02/2005-02/2007	6AT	EST-1068022105800



TT01-10-017

Cajas de transfer				
Modelo	kW/HP	Año	Caja	Referencia
525 d xDrive	145/197	09/2008-12/2010		TT01-10-017
525 i xDrive	160/218	09/2008-12/2010		TT01-10-017
525 xd	145/197	01/2007-12/2010		TT01-10-017
525 xi	160/218	07/2005-12/2010		TT01-10-017
530 d xDrive	173/235	09/2008-12/2010		TT01-10-017
530 i xDrive	200/272	09/2008-12/2010		TT01-10-017
530 xd	170/231	07/2005-12/2010		TT01-10-017
530 xd	173/235	01/2007-12/2010		TT01-10-017
530 xi	190/258	07/2005-12/2010		TT01-10-017
530 xi	200/272	01/2007-12/2010		TT01-10-017
535 xi	224/305	09/2007-12/2010		TT01-10-017



BMW 5 Touring (F11)

Imagen usada
como referencia



EST-1090016089800



Cajas de cambio automáticas 8 HP 45 HIS, 8 marchas

Modelo	kW/HP	Año	Caja	Referencia
520 d	135/184	06/2010-06/2014	8AT	EST-1090016089800
525 d	160/218	09/2011-02/2017	8AT	EST-1090016104800
525 d	160/218	09/2011-02/2017	8AT	EST-1090016144000

Cajas de cambio automáticas 1090 024 051, 8 marchas

Modelo	kW/HP	Año	Caja	Referencia
525 d xDrive	160/218	07/2013-02/2017	8AT	EST-1090026110000

Cajas de cambio automáticas 8 HP 70 X HIS, 8 marchas

Modelo	kW/HP	Año	Caja	Referencia
530 d xDrive	190/258	03/2011-02/2017	8AT	EST-1087026030800
530 d xDrive	190/258	03/2011-02/2017	8AT	EST-1087026055800
535 d xDrive	230/313	09/2011-02/2017	8AT	EST-1087026047800
535 d xDrive	230/313	09/2011-02/2017	8AT	EST-1087026061000



TT01-10-002



TT01-10-006



TT01-10-002

Cajas de transfer

Modelo	kW/HP	Año	Caja	Referencia
520 d xDrive	120/163	02/2013-	TT01-10-006	
520 d xDrive	135/184	02/2013-	TT01-10-006	
520 d xDrive	140/190	05/2014-	TT01-10-001	
525 d xDrive	155/211	09/2011-	TT01-10-006	
525 d xDrive	160/218	09/2011-	TT01-10-006	
528 i xDrive	180/245	09/2011-	TT01-10-006	
530 d xDrive	190/258	09/2011-	TT01-10-001	

Cajas de transfer

Modelo	kW/HP	Año	Caja	Referencia
530 d xDrive	210/286	10/2015-	TT01-10-001	
535 d xDrive	230/313	09/2011-	TT01-10-001	
535 i xDrive	190/258	07/2010-09/2011	TT01-10-002	
535 i xDrive	225/306	09/2011-	TT01-10-001	
535 i xDrive	240/326	10/2015-	TT01-10-001	
M 550 d xDrive	280/381	01/2012-	TT01-10-001	



TT01-10-003

Cajas de transfer

Modelo	kW/HP	Año	Caja	Referencia
520 d xDrive	140/190	07/2017-	TT01-10-003	
530 d xDrive	195/265	03/2017-06/2020	TT01-10-003	
530 i xDrive	185/252	07/2017-06/2020	TT01-10-003	
540 i xDrive	250/340	03/2017-06/2020	TT01-10-003	
540 i xDrive	265/360	03/2017-06/2020	TT01-10-003	

BMW 5 Touring Van (G31)



TT01-10-003

Cajas de transfer

Modelo	kW/HP	Año	Caja	Referencia
530 d xDrive	195/265	03/2017-		TT01-10-003
530 i xDrive	185/252	07/2017-		TT01-10-003
540 i xDrive	250/340	03/2017-		TT01-10-003

BMW 6 (E63)

Imagen usada como referencia

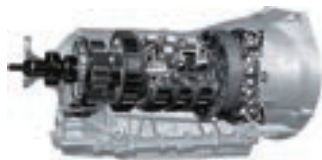

EST-1071012086800



Cajas de cambio automáticas 6 HP 19

Modelo	kW/HP	Año	Caja	Referencia
630 i	190/258	09/2004-08/2007	6AT	EST-1071012086800

Cajas de cambio automáticas 6 HP 26

Modelo	kW/HP	Año	Caja	Referencia
645 Ci	245/333	09/2003-08/2005	6AT	EST-1068012253800
650 i	270/367	09/2005-08/2010	6AT	EST-1068012400800

BMW 6 Coupé (F13)

Imagen usada como referencia

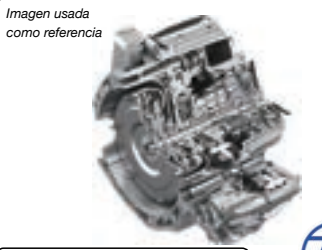

EST-1087026061000



Cajas de cambio automáticas 8 HP 70 X HIS, 8 marchas

Modelo	kW/HP	Año	Caja	Referencia
640 d xDrive	230/313	03/2012-10/2017	8AT	EST-1087026061000



TT01-10-001

Cajas de transfer

Modelo	kW/HP	Año	Caja	Referencia
640 d xDrive	230/313	03/2015-		TT01-10-001
640 i xDrive	235/320	03/2015-		TT01-10-001
650 i xDrive	298/405	03/2015-		TT01-10-001
650 i xDrive	300/408	03/2015-		TT01-10-001
650 i xDrive	330/449	03/2015-		TT01-10-001
650 i xDrive	332/452	03/2015-		TT01-10-001

BMW 6 Descapotable (E64)

Imagen usada como referencia

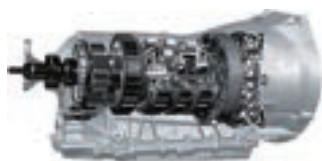

EST-1071012086800



Cajas de cambio automáticas 6 HP 19

Modelo	kW/HP	Año	Caja	Referencia
630 i	190/258	09/2004-08/2007	6AT	EST-1071012086800

Cajas de cambio automáticas 6 HP 26

Modelo	kW/HP	Año	Caja	Referencia
645 Ci	245/333	04/2004-08/2005	6AT	EST-1068012253800
6650 i	270/367	09/2005-08/2010	6AT	EST-1068012400800

BMW 6 Descapotable (F12)

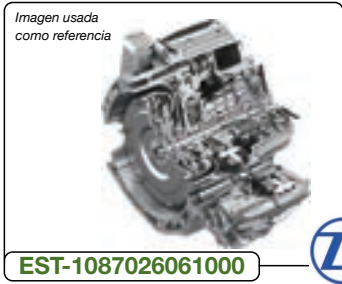

Cajas de cambio automáticas 8 HP 70 X HIS, 8 marchas				
Modelo	kW/HP	Año	Caja	Referencia
640 d xDrive	230/313	03/2012-06/2018	8AT	EST-1087026061000

Cajas de cambio automáticas 8 HP 70 X, 8 marchas				
Modelo	kW/HP	Año	Caja	Referencia
650 i xDrive	300/407	09/2011-06/2012	8AT	EST-1087022101800

Cajas de transfer				
Modelo	kW/HP	Año	Caja	Referencia
640 d xDrive	230/313	03/2015-		TT01-10-001
640 i xDrive	235/320	03/2015-		TT01-10-001
650 i xDrive	298/405	03/2015-		TT01-10-001
650 i xDrive	300/407	03/2015-		TT01-10-001
650 i xDrive	300/408	03/2015-		TT01-10-001
650 i xDrive	330/449	03/2015-		TT01-10-001
650 i xDrive	332/452	03/2015-		TT01-10-001

BMW 6 Gran Coupe (F06)



Cajas de transfer				
Modelo	kW/HP	Año	Caja	Referencia
640 d xDrive	230/313	03/2015-		TT01-10-001
640 i xDrive	235/320	03/2015-		TT01-10-001
650 i xDrive	300/408	03/2015-		TT01-10-001
650 i xDrive	330/449	03/2015-		TT01-10-001
650 i xDrive	332/452	03/2015-		TT01-10-001
650 i xDrive	335/456	03/2015-		TT01-10-001

BMW 6 Gran Turismo (G32)



Cajas de transfer				
Modelo	kW/HP	Año	Caja	Referencia
620 d xDrive	120/163	2018/07-06/2020		TT01-10-003
620 d xDrive	140/190	2018/07-06/2020		TT01-10-003
630 d xDrive	155/211	06/2017-06/2020		TT01-10-003
630 d xDrive	183/249	06/2017-06/2020		TT01-10-003
630 d xDrive	195/265	06/2017-06/2020		TT01-10-003
640 d xDrive	235/320	2017/11-06/2020		TT01-10-003
640 i xDrive	250/340	06/2017-06/2020		TT01-10-003
640 i xDrive	265/360	06/2017-06/2020		TT01-10-003



BMW 7 (E65, E66, E67)

Imagen usada como referencia

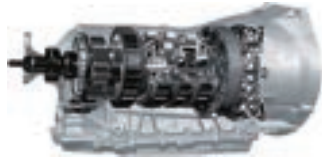

EST-1068012111800



Cajas de cambio automáticas 6 HP 26

Modelo	kW/HP	Año	Caja	Referencia
730 d	160/218	06/2002-02/2005	6AT	EST-1068012111800
730 d	160/218	06/2002-02/2005	6AT	EST-1068012160800
730 d	160/218	06/2002-02/2005	6AT	EST-1068012252800
730 d	160/218	06/2002-02/2005	6AT	EST-1068012340800
730 d	160/218	06/2002-02/2005	6AT	EST-1068012354800
730 Ld	170/231	07/2005-08/2008	6AT	EST-1068012340800
735 i, Li	200/272	11/2001-02/2005	6AT	EST-1068012107800
735 i, Li	200/272	11/2001-02/2005	6AT	EST-1068012250800
740 i, Li	225/306	03/2005-08/2008	6AT	EST-1068012337800
740 i, Li	225/306	03/2005-08/2008	6AT	EST-1068012352800
745 i, Li	245/333	07/2001-03/2005	6AT	EST-1068012106800
745 i, Li	245/333	07/2001-03/2005	6AT	EST-1068012249800
750 i, Li	270/367	03/2005-08/2008	6AT	EST-1068012336800
750 i, Li	270/367	03/2005-08/2008	6AT	EST-1068012351800
760 i, Li	327/445	01/2003-08/2008	6AT	EST-1068012185800
760 i, Li	327/445	01/2003-08/2008	6AT	EST-1068012338800
760 i, Li	327/445	01/2003-08/2008	6AT	EST-1068012339800
760 i, Li	327/445	01/2003-08/2008	6AT	EST-1068012353800
760 i, Li	327/445	01/2003-08/2008	6AT	EST-1068012462800

Cajas de cambio automáticas 6 HP 32

Modelo	kW/HP	Año	Caja	Referencia
745 d	220/300	03/2005-08/2005	6AT	EST-1070012034800

BMW 7 (F01, F02, F03, F04)

Imagen usada como referencia

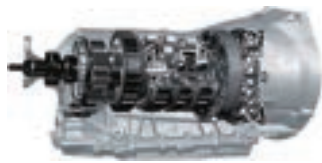

EST-1071032158800



Cajas de cambio automáticas 6 HP 21

Modelo	kW/HP	Año	Caja	Referencia
730 i, Li	190/258	09/2009-06/2015	6AT	EST-1071032158800
730 i, Li	190/258	09/2009-06/2015	6AT	EST-1071032162000
730 i, Li	190/258	09/2009-06/2015	6AT	EST-1071032168000
730 i, Li	190/258	09/2009-06/2015	6AT	EST-1071032175800
740 i, Li	240/326	09/2008-06/2012	6AT	EST-1071032161800
740 i, Li	240/326	09/2008-06/2012	6AT	EST-1071032167000
740 i, Li	240/326	09/2008-06/2012	6AT	EST-1071032173800

Cajas de cambio automáticas 6 HP 28

Modelo	kW/HP	Año	Caja	Referencia
730 d	180/245	09/2008-06/2012	6AT	EST-1068042094000
730 d	180/245	09/2008-06/2012	6AT	EST-1068042131800
730 d	180/245	09/2008-06/2012	6AT	EST-1068042145000
740 d	225/306	09/2009-06/2012	6AT	EST-1068042114800
740 d	225/306	09/2009-06/2012	6AT	EST-1068042130800
750 i, Li	300/408	09/2008-06/2012	6AT	EST-1068042116800
750 i, Li	300/408	09/2008-06/2012	6AT	EST-1068042132800
750 i, Li	300/408	09/2008-06/2012	6AT	EST-1068042146000

BMW 7 (F01, F02, F03, F04)

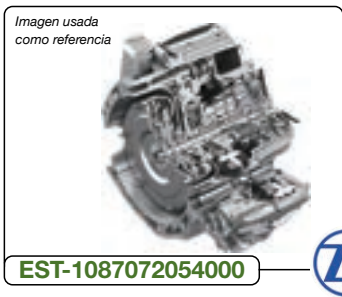

Cajas de cambio automáticas 6 HP 28 X

Modelo	kW/HP	Año	Caja	Referencia
750 i, Li xDrive	300/408	09/2009-06/2012	6AT	EST-1068052108000
750 i, Li xDrive	300/408	09/2009-06/2012	6AT	EST-1068052122800

Cajas de cambio automáticas 8 P 70 H, 8 marchas

Modelo	kW/HP	Año	Caja	Referencia
ActiveHybrid 7	260/354	08/2012-06/2015	8AT	EST-1087072054000

Cajas de transfer

Modelo	kW/HP	Año	Caja	Referencia
730 d xDrive	190/258	07/2012-12/2015		TT01-10-001
740 d xDrive	225/306	09/2009-12/2015		TT01-10-002
740 d xDrive	230/313	07/2012-12/2015		TT01-10-002
740 i, Li xDrive	235/320	07/2012-12/2015		TT01-10-001
750 Li xDrive	298/405	09/2008-12/2015		TT01-10-002
750 d xDrive	280/381	07/2012-12/2015		TT01-10-001
750 i xDrive	300/408	09/2009-12/2015		TT01-10-002
750 i xDrive	330/449	10/2012-12/2015		TT01-10-001
750 i xDrive	331/450	09/2012-12/2015		TT01-10-001

BMW 7 (G11, G12)



Cajas de transfer

Modelo	kW/HP	Año	Referencia
730 d xDrive	155/211	09/2015-06/2020	TT01-10-003
730 d, Ld xDrive	183/249	09/2015-06/2020	TT01-10-003
730 d, Ld xDrive	195/265	09/2015-06/2020	TT01-10-003
740 Le xDrive	190/258	07/2016-02/2019	TT01-10-003
740 Le xDrive	240/326	07/2016-02/2019	TT01-10-003
740 Li xDrive	250/340	03/2019-	TT01-10-003

Cajas de transfer

Modelo	kW/HP	Año	Referencia
750 Li xDrive	330/449	03/2016-02/2019	TT01-10-003
750 i, Li xDrive	330/449	09/2015-02/2019	TT01-10-003
750 i, Li xDrive	390/530	03/2019-	TT01-10-003



BMW 8 Descapotable (G14, F91)



TT01-10-003

Cajas de transfer

Modelo	kW/HP	Año	Referencia
840 i xDrive	245/333	2020/11-	TT01-10-003
840 i xDrive	250/340	07/2019-2020/10	TT01-10-003

BMW 8 Gran Coupe (G16, F93)



TT01-10-003

Cajas de transfer

Modelo	kW/HP	Año	Referencia
840 i xDrive	245/333	2020/11-	TT01-10-003
840 i xDrive	250/340	07/2019-	TT01-10-003

BMW X1 (E84)

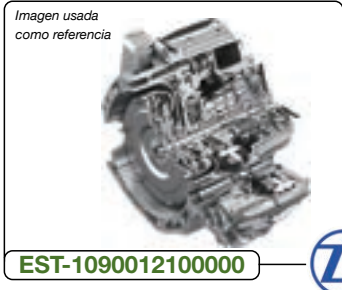

Cajas de cambio automáticas 8 HP 45, 8 marchas

Modelo	kW/HP	Año	Caja	Referencia
sDrive 20 d	130/177	10/2009-06/2015	8AT	EST-1090012100000
sDrive 20 i	135/184	09/2011-06/2015	8AT	EST-1090012100000

Cajas de cambio automáticas 8 HP 45 HIS, 8 marchas

Modelo	kW/HP	Año	Caja	Referencia
sDrive 18 d	105/143	12/2009-06/2015	8AT	EST-1090016177800
sDrive 20 d	130/177	10/2009-06/2015	8AT	EST-1090016177800

Cajas de cambio automáticas 8 HP 45 X, 8 marchas

Modelo	kW/HP	Año	Caja	Referencia
xDrive 28 i	180/245	03/2011-06/2015	8AT	EST-1090022071800

Cajas de cambio automáticas 1090 024 048, 8 marchas

Modelo	kW/HP	Año	Caja	Referencia
xDrive 18 d	105/143	10/2009-06/2015	8AT	EST-1090026138800
xDrive 20 d	130/177	09/2009-06/2012	8AT	EST-1090026138800

BMW X1 (E84)



TT01-10-004



TT01-10-010



TT01-10-005



TT01-10-011

Cajas de transfer			
Modelo	kW/HP	Año	Referencia
xDrive 18 d	100/136	03/2009-07/2012	TT01-10-004
xDrive 18 d	100/136	07/2012-06/2015	TT01-10-010
xDrive 18 d	105/143	10/2009-07/2012	TT01-10-004
xDrive 18 d	105/143	07/2012-06/2015	TT01-10-010
xDrive 20 d	120/163	03/2010-07/2012	TT01-10-004
xDrive 20 d	120/163	07/2012-06/2015	TT01-10-010
xDrive 20 d	130/177	10/2009-07/2012	TT01-10-004
xDrive 20 d	130/177	07/2012-06/2015	TT01-10-010
xDrive 20 d	135/184	07/2012-06/2015	TT01-10-010
xDrive 20 i	135/184	07/2012-06/2015	TT01-10-010
xDrive 23 d	150/204	10/2009-06/2015	TT01-10-005
xDrive 23 d	150/204	10/2009-06/2015	TT01-10-004

Cajas de transfer			
Modelo	kW/HP	Año	Referencia
xDrive 25 d	160/218	07/2012-06/2015	TT01-10-010
xDrive 25 i	160/218	01/2010-06/2015	TT01-10-004
xDrive 28 i Flex	180/245	04/2011-07/2012	TT01-10-004
xDrive 28 i	179/243	09/2011-07/2012	TT01-10-004
xDrive 28 i	179/243	07/2012-06/2015	TT01-10-010
xDrive 28 i	180/245	04/2011-07/2012	TT01-10-004
xDrive 28 i	180/245	07/2012-06/2015	TT01-10-010
xDrive 28 i	190/258	10/2009-07/2012	TT01-10-004
xDrive 28 i	190/258	07/2012-06/2015	TT01-10-010
xDrive 28 i	194/264	03/2010-06/2011	TT01-10-004
xDrive 35 i	224/305	09/2011-07/2012	TT01-10-004
xDrive 35 i	224/305	07/2012-06/2015	TT01-10-011



BMW X3 (E83)

Imagen usada como referencia

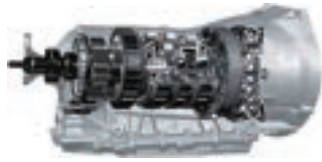

EST-1068022110800



Cajas de cambio automáticas 6 HP 26 X

Modelo	kW/HP	Año	Caja	Referencia
3.0 d	160/218	09/2005-08/2008	6AT	EST-1068022110800
3.0 d	160/218	09/2005-08/2008	6AT	EST-1068052029800
3.0 sd	210/286	09/2006-08/2008	6AT	EST-1068052012800



TT01-10-024



TT01-10-023



TT01-10-022



TT01-10-021

Cajas de transfer

Modelo	kW/HP	Año	Referencia
2.0 d	110/150	10/2004-06/2006	TT01-10-024
2.0 d	110/150	10/2004-12/2010	TT01-10-021
2.0 d	110/150	05/2006-12/2010	TT01-10-023
2.0 i	110/150	07/2005-08/2008	TT01-10-024
2.5 i	137/186	01/2004-12/2006	TT01-10-024
2.5 i	141/192	01/2004-08/2006	TT01-10-024
2.5 si xDrive	155/211	07/2006-12/2008	TT01-10-023
2.5 si	160/218	09/2006-08/2008	TT01-10-023
3.0 d	150/204	01/2004-08/2005	TT01-10-024
3.0 d	160/218	01/2004-08/2008	TT01-10-024
3.0 i xDrive	160/218	09/2006-12/2010	TT01-10-023
3.0 i xDrive	170/231	01/2004-08/2006	TT01-10-024
3.0 i	168/228	01/2004-12/2006	TT01-10-024
3.0 sd	210/286	09/2006-08/2008	TT01-10-023

Cajas de transfer

Modelo	kW/HP	Año	Referencia
3.0 si	194/264	09/2006-08/2008	TT01-10-023
3.0 si	200/272	09/2006-08/2008	TT01-10-023
xDrive 18 d	100/136	04/2009-12/2011	TT01-10-022
xDrive 18 d	105/143	09/2008-12/2011	TT01-10-022
xDrive 20 d	120/163	09/2008-08/2010	TT01-10-022
xDrive 20 d	130/177	09/2008-08/2010	TT01-10-022
xDrive 20 i	110/150	09/2008-08/2011	TT01-10-024
xDrive 25 i	160/218	09/2008-12/2011	TT01-10-023
xDrive 30 d	155/211	09/2008-04/2011	TT01-10-024
xDrive 30 d	160/218	09/2008-04/2011	TT01-10-024
xDrive 30 i	200/272	09/2008-12/2011	TT01-10-023
xDrive 30 i	200/272	09/2008-12/2011	TT01-10-024
xDrive 35 d	210/286	09/2008-08/2011	TT01-10-023

BMW X3 (F25)

Imagen usada como referencia

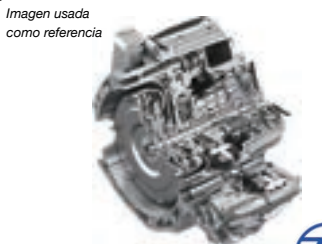

EST-1090026111000



Cajas de cambio automáticas 1090 024 080, 8 marchas

Modelo	kW/HP	Año	Caja	Referencia
xDrive 20 d	135/184	09/2010-03/2014	8AT	EST-1090026111000

BMW X3 (F25)



TT01-10-008



TT01-10-015

Cajas de transfer			
Modelo	kW/HP	Año	Referencia
xDrive 20 d	120/163	09/2010-10/2011	TT01-10-008
xDrive 20 d	120/163	10/2011-	TT01-10-015
xDrive 20 d	135/184	09/2010-10/2011	TT01-10-008
xDrive 20 d	135/184	10/2011-	TT01-10-015
xDrive 20 d	140/190	02/2014-	TT01-10-015
xDrive 20 i	110/150	04/2013-	TT01-10-015
xDrive 20 i	135/184	09/2011-	TT01-10-015
xDrive 28 d	134/182	09/2014-	TT01-10-015
xDrive 28 i	179/243	09/2010-10/2011	TT01-10-008
xDrive 28 i	179/243	10/2011-	TT01-10-015
xDrive 28 i	180/245	08/2011-	TT01-10-015
xDrive 28 i	190/258	04/2011-10/2011	TT01-10-008

Cajas de transfer			
Modelo	kW/HP	Año	Referencia
xDrive 28 i	190/258	10/2011-	TT01-10-015
xDrive 30 d	155/211	05/2011-10/2011	TT01-10-008
xDrive 30 d	155/211	10/2011-	TT01-10-015
xDrive 30 d	183/249	04/2015-	TT01-10-015
xDrive 30 d	190/258	05/2011-10/2011	TT01-10-008
xDrive 30 d	190/258	10/2011-	TT01-10-015
xDrive 30 d	204/277	06/2016-	TT01-10-015
xDrive 30 d	210/286	04/2014-	TT01-10-015
xDrive 35 d	230/313	09/2011-10/2011	TT01-10-008
xDrive 35 d	230/313	10/2011-	TT01-10-015
xDrive 35 i	225/306	09/2010-10/2011	TT01-10-008
xDrive 35 i	225/306	10/2011-	TT01-10-015

BMW X3 (G01, F97, G08)



TT01-10-003

Cajas de transfer			
Modelo	kW/HP	Año	Referencia
xDrive 20 d	120/163	08/2017-2020/03	TT01-10-003
xDrive 20 d	140/190	08/2017-12/2022	TT01-10-003
xDrive 20 i	135/184	12/2017-	TT01-10-003
xDrive 25 d	155/211	04/2018-	TT01-10-003
xDrive 25 d	170/231	04/2018-	TT01-10-003
xDrive 30 e Plug-in-Hybrid	120/163	12/2019-	TT01-10-003
xDrive 30 e Plug-in-Hybrid	135/184	12/2019-	TT01-10-003
xDrive 30 e Plug-in-Hybrid	170/231	12/2019-	TT01-10-003
xDrive 30 e Plug-in-Hybrid	185/252	12/2019-	TT01-10-003

Cajas de transfer			
Modelo	kW/HP	Año	Referencia
xDrive 30 i	183/249	08/2017-	TT01-10-003
xDrive 30 i	185/252	08/2017-	TT01-10-003
xDrive 30d Mild-Hybrid	183/249	07/2020-	TT01-10-003
xDrive 30d Mild-Hybrid	210/286	07/2020-	TT01-10-003
xDrive 30d	195/265	08/2017-06/2020	TT01-10-003
xDrive M40 d Mild-Hybrid	250/340	08/2018-	TT01-10-003
xDrive M40 d	240/326	08/2018-06/2020	TT01-10-003
xDrive M40 i	260/354	09/2018-08/2019	TT01-10-003
xDrive M40 i	265/360	08/2017-	TT01-10-003
xDrive M40 i	285/387	09/2019-	TT01-10-003

BMW X3 Van (G01)



TT01-10-003

Cajas de transfer

Modelo	kW/HP	Año	Referencia
xDrive 20 d	140/190	08/2017-	TT01-10-003
xDrive 20 i	135/184	12/2017-	TT01-10-003
xDrive 30 d	195/265	08/2017-	TT01-10-003
xDrive 30 i	185/252	08/2017-	TT01-10-003
xDrive M40 i	265/360	08/2017-08/2019	TT01-10-003
xDrive M40 i	285/387	09/2019-	TT01-10-003

BMW X4 (F26)



TT01-10-015

Cajas de transfer

Modelo	kW/HP	Año	Referencia
M 40 i	265/360	12/2015-	TT01-10-015
xDrive 20 d	120/163	06/2014-	TT01-10-015
xDrive 20 d	140/190	04/2014-	TT01-10-015
xDrive 20 i	135/184	04/2014-	TT01-10-015
xDrive 28 i	180/245	04/2014-	TT01-10-015
xDrive 30 d	155/211	04/2014-	TT01-10-015

Cajas de transfer

Modelo	kW/HP	Año	Referencia
xDrive 30 d	183/249	04/2015-	TT01-10-015
xDrive 30 d	190/258	04/2014-	TT01-10-015
xDrive 30 d	204/277	06/2016-	TT01-10-015
xDrive 30 d	210/286	04/2014-	TT01-10-015
xDrive 35 d	230/313	04/2014-	TT01-10-015
xDrive 35 i	225/306	04/2014-	TT01-10-015

BMW X4 (G01, F97)



TT01-10-003

Cajas de transfer

Modelo	kW/HP	Año	Referencia
xDrive 30d	183/249	12/2017-06/2020	TT01-10-003



BMW X4 - (G02, F98)



TT01-10-003

Cajas de transfer

Modelo	kW/HP	Año	Referencia
M40 d Mild-Hybrid xDrive	250/340	07/2020-	TT01-10-003
M40 d xDrive	240/326	04/2018-06/2020	TT01-10-003
M40 i xDrive	260/354	04/2018-08/2019	TT01-10-003
M40 i xDrive	265/360	04/2018-	TT01-10-003
M40 i xDrive	285/387	09/2019-	TT01-10-003
xDrive 20 d xDrive	120/163	04/2018-03/2020	TT01-10-003

Cajas de transfer

Modelo	kW/HP	Año	Referencia
xDrive 20 d	140/190	04/2018-12/2021	TT01-10-003
xDrive 20 i	135/184	04/2018-	TT01-10-003
xDrive 25 d	155/211	04/2018-	TT01-10-003
xDrive 25 d	170/231	04/2018-	TT01-10-003
xDrive 30 d Mild-Hybrid	183/249	07/2020-	TT01-10-003
xDrive 30 d Mild-Hybrid	210/286	07/2020-	TT01-10-003
xDrive 30 d	183/249	09/2018-06/2020	TT01-10-003
xDrive 30 i	183/249	04/2018-	TT01-10-003
xDrive 30 i	185/252	04/2018-	TT01-10-003

BMW X4 (G05, F98)



TT01-10-003

Cajas de transfer

Modelo	kW/HP	Año	Referencia
xDrive 20 d Mild-Hybrid	120/163	04/2020-	TT01-10-003
xDrive 20 d Mild-Hybrid	140/190	04/2020-	TT01-10-003

BMW X5 (E53)

Imagen usada como referencia

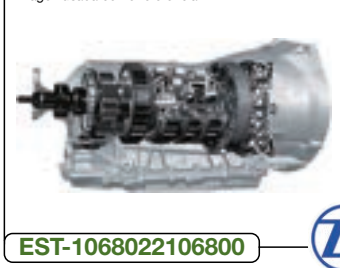

EST-1068022106800



Cajas de cambio automáticas 6 HP 26 X

Modelo	kW/HP	Año	Caja	Referencia
3.0 d	160/218	10/2003-09/2006	6AT	EST-1068022106800
4.4 i	235/320	10/2003-10/2006	6AT	EST-1068022090800
4.8 is	265/360	04/2004-09/2006	6AT	EST-1068022092800



TT01-10-025



TT01-10-027

Cajas de transfer

Modelo	kW/HP	Año	Caja	Referencia
3.0 d	155/211	09/2023-12/2006		TT01-10-025
3.0 d	160/218	12/2003-12/2006		TT01-10-025
3.0 i	163/222	10/2003-12/2006		TT01-10-025
3.0 i	170/231	10/2003-12/2006		TT01-10-025
3,0	168/228	10/2003-12/2006		TT01-10-025
4.4 i	235/320	12/2003-09/2006		TT01-10-025
4.6 is	255/347	02/2002-12/2003		TT01-10-027
4.6 is	261/355	09/2021-12/2003		TT01-10-027
4.8 is	265/360	04/2004-09/2006		TT01-10-025

BMW X5 (E70)

Imagen usada como referencia



EST-1071052076000



Cajas de cambio automáticas 6 HP 21 X

Modelo	kW/HP	Año	Caja	Referencia
xDrive 30 i	200/272	10/2008-03/2010	6AT	EST-1071052076000

Cajas de cambio automáticas 6 HP 28 X

Modelo	kW/HP	Año	Caja	Referencia
3.0 d	173/235	12/2006-09/2008	6AT	EST-1068052014800
3.0 d	173/235	12/2006-09/2008	6AT	EST-1068052052800
3.0 d	173/235	12/2006-09/2008	6AT	EST-1068052053000
3.0 d	173/235	12/2006-09/2008	6AT	EST-1068052072800
3.0 sd	210/286	10/2007-09/2008	6AT	EST-1068052069800
3.0 sd	210/286	10/2007-09/2008	6AT	EST-1068052132000
4.8 i xDrive	261/355	10/2006-09/2008	6AT	EST-1068052015800
xDrive 30 d	173/235	10/2008-03/2010	6AT	EST-1068052111800
xDrive 35 d	210/286	10/2008-07/2013	6AT	EST-1068052110800
xDrive 35 d	210/286	10/2008-07/2013	6AT	EST-1068052115800
xDrive 35 d	210/286	10/2008-07/2013	6AT	EST-1068052132000
xDrive 48 i	261/355	10/2008-03/2010	6AT	EST-1068052112000
M	408/555	07/2009-07/2013	6AT	EST-1068052107000
M	408/555	07/2009-07/2013	6AT	EST-1068052116800
M	408/555	07/2009-07/2013	6AT	EST-1068052133800

Imagen usada como referencia



EST-1090022072800



Cajas de cambio automáticas 8 HP 45 X, 8 marchas

Modelo	kW/HP	Año	Caja	Referencia
xDrive 35 i	225/306	04/2010-07/2013	8AT	EST-1090022072800
xDrive 35 i	225/306	04/2010-07/2013	8AT	EST-1090022110000
xDrive 35 i	225/306	04/2010-07/2013	8AT	EST-1090022115000

Cajas de cambio automáticas 8 HP 70 X, 8 marchas

Modelo	kW/HP	Año	Caja	Referencia
xDrive 30 d	180/245	04/2010-07/2013	8AT	EST-1087022097800
xDrive 40 d	225/306	09/2010-06/2013	8AT	EST-1087022098000
xDrive 50 i	300/408	04/2010-07/2013	8AT	EST-1087022099000
xDrive 50 i	300/408	04/2010-07/2013	8AT	EST-1087022100000
M 50 d	280/381	08/2011-06/2013	8AT	EST-1087022090800



BMW X5 (E70)



TT01-10-019



TT01-10-026



TT01-10-013



TT01-10-014



TT01-10-007



TT01-10-009

Cajas de transfer

Modelo	kW/HP	Año	Caja	Referencia
3.0 d	135/184	02/2007-06/2013		TT01-10-019
3.0 d	155/211	02/2007-09/2008		TT01-10-019
3.0 d	173/235	02/2007-09/2008		TT01-10-019
3.0 sd	210/286	09/2007-02/2009		TT01-10-019
3.0 si	171/230	02/2007-09/2008		TT01-10-019
3.0 si	200/272	02/2007-09/2008		TT01-10-019
4.8 i xDrive	261/355	02/2007-09/2008		TT01-10-019
M 50 d	280/381	04/2012-06/2013		TT01-10-013
M	408/555	09/2009-06/2013		TT01-10-026
xDrive 30 d	155/211	09/2008-04/2012		TT01-10-007
xDrive 30 d	155/211	04/2012-06/2013		TT01-10-013
xDrive 30 d	173/235	09/2008-04/2012		TT01-10-007
xDrive 30 d	173/235	04/2012-06/2013		TT01-10-013
xDrive 30 d	180/245	09/2010-04/2012		TT01-10-007
xDrive 30 d	180/245	04/2012-06/2013		TT01-10-013
xDrive 30 i	171/230	09/2008-12/2010		TT01-10-019

Cajas de transfer

Modelo	kW/HP	Año	Caja	Referencia
xDrive 30 i	172/234	02/2007-12/2012		TT01-10-019
xDrive 30 i	200/272	09/2008-03/2010		TT01-10-019
xDrive 35 d	198/269	09/2008-12/2012		TT01-10-019
xDrive 35 d	210/286	09/2008-06/2013		TT01-10-019
xDrive 35 i	225/306	09/2010-04/2012		TT01-10-007
xDrive 35 i	225/306	04/2012-06/2013		TT01-10-013
xDrive 35 i	235/320	02/2012-04/2012		TT01-10-007
xDrive 35 i	235/320	04/2012-06/2013		TT01-10-013
xDrive 40 d	225/306	09/2010-04/2012		TT01-10-007
xDrive 40 d	225/306	04/2012-06/2013		TT01-10-013
xDrive 40 i	225/306	01/2012-06/2013		TT01-10-013
xDrive 48 i	261/355	09/2008-06/2013		TT01-10-019
xDrive 50 i	298/405	09/2009-04/2012		TT01-10-009
xDrive 50 i	298/405	04/2012-06/2013		TT01-10-014
xDrive 50 i	300/408	06/2010-04/2012		TT01-10-009
xDrive 50 i	300/408	04/2012-06/2013		TT01-10-014

BMW X5 (F15, F85)



TT01-10-015



TT01-10-016



TT01-10-012

Cajas de transfer				
Modelo	kW/HP	Año	Caja	Referencia
M 50 d	280/381	07/2013-		TT01-10-015
M	423/575	12/2014-		TT01-10-012
xDrive 25 d	155/211	11/2013-		TT01-10-015
xDrive 25 d	160/218	11/2013-		TT01-10-015
xDrive 25 d	170/231	07/2015-		TT01-10-015
xDrive 28 i	180/245	09/2015-		TT01-10-015
xDrive 30 d	183/249	04/2015-		TT01-10-015
xDrive 30 d	190/258	07/2013-		TT01-10-015
xDrive 30 d	204/277	11/2013-		TT01-10-015
xDrive 35 i	225/306	11/2013-		TT01-10-015

Cajas de transfer				
Modelo	kW/HP	Año	Caja	Referencia
xDrive 35 i	240/326	11/2013-		TT01-10-015
xDrive 40 d	230/313	12/2013-		TT01-10-015
xDrive 40e	155/211	09/2015-		TT01-10-015
xDrive 40e	180/245	09/2015-		TT01-10-015
xDrive 40e	205/279	09/2015-		TT01-10-015
xDrive 40e	230/313	09/2015-		TT01-10-015
xDrive 50 i	300/408	02/2014-		TT01-10-016
xDrive 50 i	330/449	07/2013-		TT01-10-016
xDrive 50 i	332/452	07/2013-		TT01-10-016

BMW X5 (G02, F98)



TT01-10-003

Cajas de transfer				
Modelo	kW/HP	Año	Caja	Referencia
xDrive 30 d	195/265	2018/04-06/2020		TT01-10-003

BMW X5 (G05, F95)



TT01-10-003

Cajas de transfer			
Modelo	kW/HP	Año	Referencia
xDrive 25 d	155/211	08/2019-	TT01-10-003
xDrive 25 d	170/231	08/2019-	TT01-10-003
xDrive 30 i	195/265	2019/09-	TT01-10-003

Cajas de transfer			
Modelo	kW/HP	Año	Referencia
xDrive 40 i Mild-Hybrid	245/333	12/2020-	TT01-10-003
xDrive 40 i	250/340	2018/08-	TT01-10-003
sDrive 40 i	250/340	08/2019-	TT01-10-003

BMW X5 Van (G05)



TT01-10-003

Cajas de transfer

Modelo	kW/HP	Año	Caja	Referencia
xDrive 40 i	250/340	11/2019-		TT01-10-003

BMW X6 (E71, E72)

Imagen usada como referencia

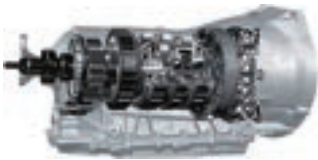

EST-1071052076000



Cajas de cambio automáticas 6 HP 21 X

Modelo	kW/HP	Año	Caja	Referencia
xDrive 35 i	225/306	01/2008-07/2014	6AT	EST-1071052075800

Cajas de cambio automáticas 6 HP 28 X

Modelo	kW/HP	Año	Caja	Referencia
xDrive 30 d	173/235	04/2008-03/2010	6AT	EST-1068052111800
xDrive 35 d	210/286	01/2008-03/2010	6AT	EST-1068052110800
xDrive 50 i	300/408	07/2008-07/2014	6AT	EST-1068052113000
M	408/555	07/2009-07/2014	6AT	EST-1068052107000
M	408/555	07/2009-07/2014	6AT	EST-1068052116800
M	408/555	07/2009-07/2014	6AT	EST-1068052133800

Imagen usada como referencia



EST-1090022072800



Cajas de cambio automáticas 8 HP 45 X, 8 marchas

Modelo	kW/HP	Año	Caja	Referencia
xDrive 35 i	225/306	01/2008-07/2014	8AT	EST-1090022072800
xDrive 35 i	225/306	01/2008-07/2014	8AT	EST-1090022110000
xDrive 35 i	225/306	01/2008-07/2014	8AT	EST-1090022115000

Cajas de cambio automáticas 8 HP 70 X, 8 marchas

Modelo	kW/HP	Año	Caja	Referencia
xDrive 30 d	180/245	04/2010-07/2014	8AT	EST-1087022097800
xDrive 40 d	225/306	07/2009-06/2014	8AT	EST-1087022098000
xDrive 50 i	300/408	07/2008-07/2014	8AT	EST-1087022099000



BMW X6 (E71, E72)



TT01-10-019



TT01-10-026



TT01-10-013



TT01-10-014



TT01-10-007



TT01-10-009



TT01-10-020

Cajas de transfer

Modelo	kW/HP	Año	Caja	Referencia
30 d	173/235	05/2008-08/2008		TT01-10-019
35 d	210/286	05/2008-08/2008		TT01-10-019
35 i	225/306	05/2008-08/2008		TT01-10-019
50 i	300/408	05/2008-06/2009		TT01-10-026
50 i	300/408	06/2009-2012/04		TT01-10-009
50 i	300/408	2012/04-06/2014		TT01-10-014
ActiveHybrid	300/408	01/2009-10/2011		TT01-10-020
ActiveHybrid	357/485	01/2009-10/2011		TT01-10-020
M 50 d	280/381	08/2011-06/2014		TT01-10-013
M	408/555	07/2008-06/2014		TT01-10-026
M	414/563	07/2008-06/2014		TT01-10-026
M	423/575	07/2009-06/2014		TT01-10-026
xDrive 30 d	155/211	07/2009-2012/04		TT01-10-007
xDrive 30 d	155/211	2012/04-06/2014		TT01-10-013
xDrive 30 d	173/235	09/2007-03/2010		TT01-10-007
xDrive 30 d	180/245	04/2009-2012/04		TT01-10-007
xDrive 30 d	180/245	2012/04-06/2014		TT01-10-013

Cajas de transfer

Modelo	kW/HP	Año	Caja	Referencia
xDrive 35 d	210/286	2007/06-03/2010		TT01-10-026
xDrive 35 i	225/306	2007/06-03/2010		TT01-10-007
xDrive 35 i	235/320	07/2009-2012/04		TT01-10-007
xDrive 35 i	235/320	2012/04-06/2014		TT01-10-013
xDrive 35 i	240/326	2007/06-03/2010		TT01-10-026
xDrive 40 d	225/306	07/2009-2012/04		TT01-10-007
xDrive 40 d	225/306	2012/04-06/2014		TT01-10-013
xDrive 50 i	298/405	10/2007-06/2009		TT01-10-026
xDrive 50 i	298/405	06/2009-2012/04		TT01-10-009
xDrive 50 i	298/405	2012/04-06/2014		TT01-10-014
xDrive 50 i	300/408	10/2007-06/2009		TT01-10-026
xDrive 50 i	300/408	06/2009-2012/04		TT01-10-009
xDrive 50 i	300/408	2012/04-06/2014		TT01-10-014
xDrive 50 i	330/449	10/2007-06/2009		TT01-10-026
xDrive 50 i	330/449	06/2009-2012/04		TT01-10-009
xDrive 50 i	330/449	2012/04-06/2014		TT01-10-014



BMW X6 (F16, F86)



TT01-10-015



TT01-10-016



TT01-10-012

Cajas de transfer			
Modelo	kW/HP	Año	Referencia
M 50 d	280/381	08/2014-	TT01-10-015
M	423/575	12/2014-	TT01-10-012
xDrive 28 i	180/245	09/2015-	TT01-10-015
xDrive 30 d	155/211	08/2014-	TT01-10-015
xDrive 30 d	160/218	09/2016-	TT01-10-015
xDrive 30 d	183/249	12/2015-	TT01-10-015
xDrive 30 d	190/258	08/2014-	TT01-10-015

Cajas de transfer			
Modelo	kW/HP	Año	Referencia
xDrive 30 d	204/277	02/2015-	TT01-10-015
xDrive 35 i	225/306	12/2014-	TT01-10-015
xDrive 35 i	240/326	02/2015-	TT01-10-015
xDrive 40 d	230/313	12/2014-	TT01-10-015
xDrive 50 i	300/408	11/2014-	TT01-10-016
xDrive 50 i	330/449	08/2014-	TT01-10-016

BMW X6 (G06, F96)



TT01-10-003

Cajas de transfer			
Modelo	kW/HP	Año	Referencia
xDrive 30 i	195/265	11/2019-	TT01-10-003
xDrive 40 i Mild-Hybrid	245/333	12/2020-	TT01-10-003
xDrive 40 i	250/340	08/2019-	TT01-10-003

BMW X7 (G07)



TT01-10-003

Cajas de transfer			
Modelo	kW/HP	Año	Referencia
xDrive 40 i Mild-Hybrid	245/333	12/2020-	TT01-10-003

300C Touring (LX, LE)



FOTO
NO DISPONIBLE

TT04-12-001



FOTO
NO DISPONIBLE

TT01-12-002

Diferencial

Modelo	kW/HP	Año	Caja	Referencia
3.5 AWD	183/249	09/2004-12/2010		TT04-12-001
5.7 AWD	250/340	04/2005-12/2010		TT04-12-001

Cajas de transfer

Modelo	kW/HP	Año	Caja	Referencia
3.5 AWD	183/249	09/2004-12/2010		TT01-12-002
5.7 AWD	250/340	04/2005-12/2010		TT01-12-002

Daihatsu



Rocky / Rugger F70 / Terios



BT20CC001



BT20CT001

Cajas de cambio

Modelo	kW/HP	Año	Caja	Referencia
Rocky, Rugger F70 y Terios				BT20CC001

Cajas de cambio y transfer

Modelo	kW/HP	Año	Caja	Referencia
Rocky, Rugger F70 y Terios				BT20CT001

Dodge



Charger



FOTO
NO DISPONIBLE

TT02-12-002

Diferencial delantero

Modelo	kW/HP	Año	Caja	Referencia
5.7 R/T AWD	276/375	09/2010-		TT02-12-002

Fiat Panda (169_)



TT03-21-005



TT03-21-001



TT03-21-002



TT03-21-003

Diferencial eje trasero

Modelo	kW/HP	Año	Referencia
1.2 4x4	44/60	10/2004-03/2012	TT03-21-001
1.2 4x4	44/60	10/2004-03/2012	TT03-21-005
1.2 4x4	51/69	11/2009-03/2012	TT03-21-005
1.2 4x4	51/69	11/2009-03/2012	TT03-21-001

Diferencial eje trasero

Modelo	kW/HP	Año	Referencia
1.3 D Multijet 4x4	51/70	10/2004-03/2012	TT03-21-003
1.3 D Multijet 4x4	51/70	10/2004-03/2012	TT03-21-002
1.3 D Multijet 4x4	55/75	09/2010-03/2012	TT03-21-003
1.3 D Multijet 4x4	55/75	09/2010-03/2012	TT03-21-002

Fiat Panda Van (169_)



TT03-21-001



TT03-21-002



TT03-21-003

Eje trasero

Modelo	kW/HP	Año	Referencia
1.2 4x4	44/60	09/2004-03/2012	TT03-21-005
1.2 4x4	44/60	09/2004-03/2012	TT03-21-001
1.2 4x4	51/69	09/2010-03/2012	TT03-21-005
1.2 4x4	51/69	09/2010-03/2012	TT03-21-001

Eje trasero

Modelo	kW/HP	Año	Referencia
1.3 D Multijet 4x4	51/70	10/2004-03/2012	TT03-21-003
1.3 D Multijet 4x4	51/70	10/2004-03/2012	TT03-21-002
1.3 D Multijet 4x4	55/75	01/2006-03/2012	TT03-21-002
1.3 D Multijet 4x4	55/75	01/2006-03/2012	TT03-21-003

Fiat Panda (312_, 319_)



TT03-21-004

Diferencial trasero

Modelo	kW/HP	Año	Referencia
0.9 4x4	63/86	09/2012-	TT03-21-004
0.9 4x4	66/90	06/2014-	TT03-21-004
1.3 D Multijet 4x4	55/75	06/2012-	TT03-21-004
1.3 D Multijet 4x4	59/80	06/2014-	TT03-21-004
1.3 D Multijet 4x4	70/95	04/2015-	TT03-21-004

Maverick, Ranger 5 y 6 vel., Explorer



BT32CC001



BT32CC005

Cajas de cambio			
Modelo	kW/HP	Año	Referencia
Ranger 2.5 diesel		1998-2006	BT32CC001
Ranger 2500 4x4		2006-2010	BT32CC003
Ranger 2500 4x4 5 velocidades		2011-	BT32CC004
Ranger 2500 4x4 6 velocidades		2011-	BT32CC005

Cajas de cambio			
Modelo	kW/HP	Año	Referencia
Ranger 2.2 4x4 6 velocidades CON start & stop		2012	BT32CC006
Ranger 2.2 4x4 6 velocidades SIN start & stop		2012	BT32CC007

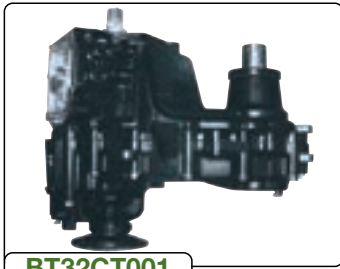

BT32CT001



BT32CT004

Cajas de transfer			
Modelo	kW/HP	Año	Referencia
Ranger		-2006	BT32CT001
Ranger		2006-2010	BT32CT002

Cajas de transfer			
Modelo	kW/HP	Año	Referencia
Ranger 5 velocidades		2011-	BT32CT003
Ranger 6 velocidades		2011-	BT32CT004



BT32AT001

Cajas completas			
Modelo	kW/HP	Año	Referencia
Ranger 2.5 diesel		2000-2006	BT32AT001

Cajas completas			
Modelo	kW/HP	Año	Referencia
Ranger 2500 5 velocidades		2006-2012	BT32AT002

Honda CRV



BT46CC001



BT46CT001



BT46CT002

Cajas de cambio

Modelo	kW/HP	Año	Referencia
2.0 gasolina 5 velocidades		2002	BT46CC001

Cajas de transfer

Modelo	kW/HP	Año	Referencia
2.2, 5 y 6 velocidades		2009	BT46CT001
2.2, 5 y 6 velocidades		-2009	BT46CT002

Hyundai

Santa Fé / Terracán



BT45CC001



BT45CC002



BT45CC003



BT45CT001

Cajas de cambio

Modelo	kW/HP	Año	Referencia
Santa Fe 2.5 diesel		2001	BT45CC001
Modelos con motor transversal. También Santa Fe motor 2000 diesel (2002 en adelante). 5 velocidades. Carcasa aluminio. Con interruptor marcha atrás.			
Santa Fe 2.5 diesel		2001	BT45CC001
Modelos con motor transversal. También Santa Fe motor 2000 diesel (2002 en adelante). 6 velocidades. Carcasa aluminio. Con interruptor marcha atrás.			
Terracán 2.5 diesel. 5 velocidades (todos)			BT45CC003
Santa Fe 2.0, 6 velocidades		2010-2015	BT45CC004
ix35, 6 velocidades		2010-2015	BT45CC005

Cajas de transfer

Modelo	kW/HP	Año	Referencia
Santa Fe 2.7 V6 gasolina y diesel		2001	BT45CT001
También modelo Tucson. Eje con 3 coronas estriadas. 4 y 5 velocidades.			
Santa Fe 2.7 V6 gasolina y diesel		2001	BT45CT002
También modelo Tucson.. Eje con 2 coronas estriadas. 6 velocidades.			
Terracán cambio automático			BT45CT003
Terracán cambio manual			BT45CT004
Génesis 3.8 GDI 4WD	232/315	06/2014-07/2017	TT01-48-001

KB 2.5, 2.8, 3.0 / Rodeo / Trooper



BT30CC003



BT30CT001



BT30AT001

Cajas de cambio			
Modelo	kW/HP	Año	Referencia
Jacobs 2800 4 cil.		1988	BT30CC001
Rodeo 3000 TD		2006	BT30CC002
DMax 2.500 cc con doble turbo, 6 vel.			BT30CC003

Cajas de transfer			
Modelo	kW/HP	Año	Referencia
D-Max (modelo Rodeo)		2005-	BT30CT001
No se suministra con el motor eléctrico, 4x4			

Cajas completas			
Modelo	kW/HP	Año	Referencia
Trooper 3000 diesel		2000	BT30AT001
Conexión transfer eléctrica			
Trooper 3100 diesel		1994	BT30AT002



Jaguar



F-TYPE



BT26CT001

Cajas de cambio				
Modelo	kW/HP	Año	Caja	Referencia
X-Type				BT26CC001

Cajas de transfer				
Modelo	kW/HP	Año	Caja	Referencia
X-Type				BT26CT001

F-TYPE Coupé (X152)



TT01-00-005

Cajas de transfer

Modelo	kW/HP	Año	Caja	Referencia
3.0 S	280/380	12/2014-		TT01-00-005
3,0	250/340	08/2017-		TT01-00-005
400	294/400	11/2016-		TT01-00-005
5.0 R	405/551	12/2014-		TT01-00-005
5.0 SVR	423/575	12/2015-		TT01-00-005

F-TYPE Descapotable (X152)



TT01-00-005

Cajas de transfer

Modelo	kW/HP	Año	Caja	Referencia
3.0 S	280/380	12/2014-		TT01-00-005
3,0	250/340	08/2017-		TT01-00-005
400	294/400	11/2016-		TT01-00-005
5.0 R	405/551	12/2014-		TT01-00-005
5.0 SVR	423/575	12/2015-		TT01-00-005

S-TYPE II (X200)

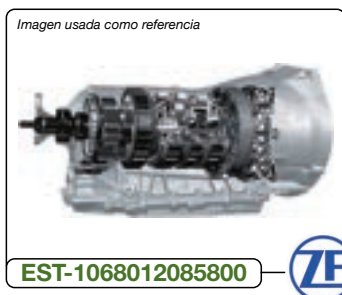

EST-1068012085800



Cajas de cambio automáticas 6 HP 26

Modelo	kW/HP	Año	Caja	Referencia
2.5 V6	147/200	04/2002-10/2007	6AT	EST-1068012085800
2.5 V6	147/200	04/2002-10/2007	6AT	EST-1068012317800
3.0 V6	175/238	01/1999-10/2007	6AT	EST-1068012084800
3.0 V6	175/238	01/1999-10/2007	6AT	EST-1068012316800
4.2 V8	219/298	04/2002-10/2007	6AT	EST-1068012386800

XF I (X250)

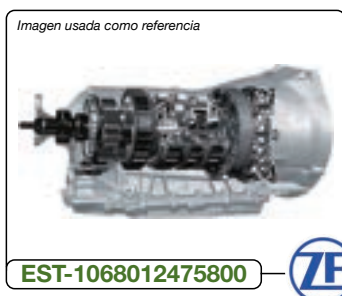

EST-1068012475800

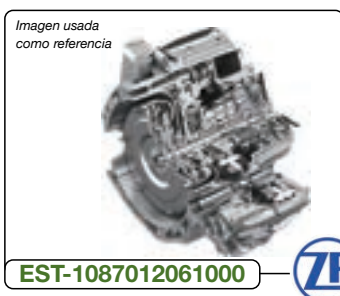

EST-1087012061000



Cajas de cambio automáticas 6 HP 26

Modelo	kW/HP	Año	Caja	Referencia
3.0	175/238	03/2008-04/2015	6AT	EST-1068012475800
3.0	175/238	03/2008-04/2015	6AT	EST-1068012553800

Cajas de cambio automáticas 8 HP 70, 8 marchas

Modelo	kW/HP	Año	Caja	Referencia
2.2 D	140/190	05/2011-04/2015	8AT	EST-1087012061000
3.0 D	202/275	03/2009-04/2015	8AT	EST-1087012065000

Cajas de cambio automáticas 8 HP 70 HIS, 8 marchas

Modelo	kW/HP	Año	Caja	Referencia
2.2 D	140/190	05/2011-04/2015	8AT	EST-1087016043800
3.0 D	202/275	03/2009-04/2015	8AT	EST-1087016035800

XJ (X350, X358)

Imagen usada como referencia

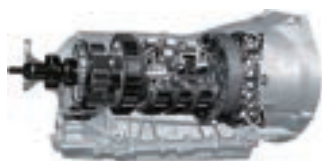

EST-1068012085800



Cajas de cambio automáticas 6 HP 26

Modelo	kW/HP	Año	Caja	Referencia
3.0	175/238	05/2003-03/2009	6AT	EST-1068012156800
4.2	219/298	05/2003-03/2009	6AT	EST-1068012154800
4.2	219/298	05/2003-03/2009	6AT	EST-1068012212800
4.2	219/298	05/2003-03/2009	6AT	EST-1068012320800
D 2.7	152/207	10/2005-03/2009	6AT	EST-1068012492800

XJ (X351)

Imagen usada como referencia



EST-1087016035800



Cajas de cambio automáticas 8 HP 70, 8 marchas

Modelo	kW/HP	Año	Caja	Referencia
3.0 SDV6	202/275	10/2009-04/2016	8AT	EST-1087012065000

Cajas de cambio automáticas 8 HP 70 HIS, 8 marchas

Modelo	kW/HP	Año	Caja	Referencia
3.0 SDV6	202/275	10/2009-04/2016	8AT	EST-1087016035800



TT01-00-005

Cajas de transfer

Modelo	kW/HP	Año	Caja	Referencia
3,0	250/340	10/2015-		TT01-00-005
3,0	253/344	10/2015-		TT01-00-005

XK 8 Convertible y Coupé (X100)

Imagen usada como referencia

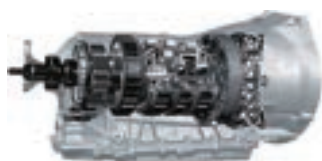

EST-1068012209800



Cajas de cambio automáticas 6 HP 26

Modelo	kW/HP	Año	Caja	Referencia
4.2	219/298	08/2002-12/2006	6AT	EST-1068012209800
4.2	219/298	08/2002-07/2005	6AT	EST-1068012209800

XK II Coupé (X150)

Imagen usada como referencia

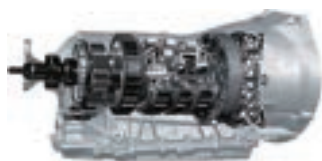

EST-1068042097000



Cajas de cambio automáticas 6 HP 28

Modelo	kW/HP	Año	Caja	Referencia
5.0 XKR	375/510	01/2009-07/2014	6AT	EST-1068042097000

Cherokee



BT10CC001

Cajas de cambio

Modelo	kW/HP	Año	Caja	Referencia
2500 D y 4000 gasolina		1994-2001		BT10CC001
Interruptor de luz de marcha atrás en el lado derecho. Estrías primario: 10				
2500 gasolina		-2000		BT10CC002
Carcasa hierro/aluminio. Estrías primario: 14				
2500 D y gasolina y 4000 gasolina		2002-2005		BT10CC003
Interruptor de luz de marcha atrás en el lado izquierdo. Estrías primario: 10				
6 velocidades (todos)				BT10CC005

Grand Cherokee / Wrangler

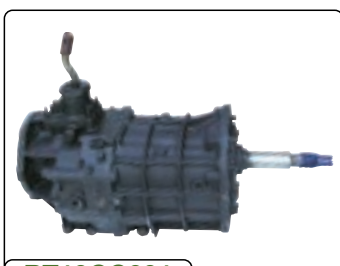

BT10CC001

Cajas de cambio

Modelo	kW/HP	Año	Caja	Referencia
2500 D y 4000 gasolina		1994-2001		BT10CC001
Interruptor de luz de marcha atrás en el lado derecho. Estrías primario: 10				
2500 gasolina		-2000		BT10CC002
Carcasa hierro/aluminio. Estrías primario: 14				
2500 D y gasolina y 4000 gasolina		2002-2005		BT10CC003
Interruptor de luz de marcha atrás en el lado izquierdo. Estrías primario: 10				
6 velocidades (todos)				BT10CC005

Cherokee (KJ)



TT01-12-005

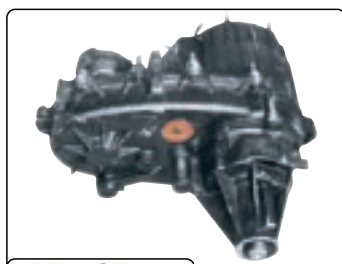

BT10CT001

Cajas de transfer

Modelo	kW/HP	Año	Caja	Referencia
2.4 4x4	108/147	09/2001-01/2008		TT01-12-005
2.4 4x4	112/152	09/2001-12/2005		TT01-12-005
2.5 CRD 4x4	105/143	09/2001-01/2008		TT01-12-005
2.8 CRD 4x4	110/150	11/2002-01/2008		TT01-12-005
2.8 CRD 4x4	120/163	11/2004-01/2008		TT01-12-005
3.7 4x4	150/204	08/2003-01/2008		TT01-12-005
3.7 4x4	151/205	03/2001-12/2007		TT01-12-005
3.7 4x4	155/211	09/2001-01/2008		TT01-12-005
3.7 4x4	157/214	09/2001-10/2007		TT01-12-005
Gasolina				BT10CT001
2 interruptores (de 3 pines y 4 pines). Transmisión directa a caja cambios				

Jeep Liberty (KJ)



TT01-12-005

Cajas de transfer

Modelo	kW/HP	Año	Caja	Referencia
2.4 4x4	108/147	09/2001-01/2008		TT01-12-005
2.4 4x4	112/152	09/2001-12/2005		TT01-12-005
2.5 CRD 4x4	105/143	09/2001-01/2008		TT01-12-005
2.8 CRD 4x4	110/150	11/2002-01/2008		TT01-12-005
2.8 CRD 4x4	120/163	11/2004-01/2008		TT01-12-005
3.7 4x4	150/204	08/2003-01/2008		TT01-12-005
3.7 4x4	151/205	03/2001-12/2007		TT01-12-005
3.7 4x4	155/211	09/2001-01/2008		TT01-12-005
3.7 4x4	157/214	09/2001-10/2007		TT01-12-005

Grand Cherokee



BT10CT001



BT10CT007



BT10CT014



BT10CT017

Cajas de transfer

Modelo	kW/HP	Año	Caja	Referencia
Gasolina				BT10CT001
2 interruptores (de 3 pines y 4 pines). Transmisión directa a caja cambios.				
2500 diesel		1995		BT10CT002
2 interruptores de 4 pines y 3 pines. Transmisión entra en transfer a través de eje corredera.				
4000 cc				BT10CT003
2 interruptores de 2 pines. Transmisión entra a través de eje. Vehículo 4x4 conectable.				
Laredo 4000 gasolina		1999		BT10CT004
Modelo 247J, ratio 272. Longitud: 22 mm.				
Laredo 2500 VM		1998		BT10CT006
Para cambio manual, 2 interruptor 4 pines. Numeración chapa 231J. Se necesita la numeración que aparece en el disco de la caja.				
3100 TDi				BT10CT007
Numeración disco: J247. También para modelos Grand Cherokee y Cherokee gasolina. La transmisión trasera va unida con brida de 4 tornillos. Se necesita la numeración que aparece en el disco de la caja.				
2500 VM para cambio manual		1998		BT10CT008
2 interruptor 4 pines. Numeración chapa 231J. Se necesita la numeración que aparece en el disco de la caja.				
V8 4.7 con cambio automático				BT10CT009
Se necesita la numeración que aparece en el disco de la caja.				
Laredo 2500 VM				BT10CT010
2 interruptores (1 de 3 pines y otro de 4). Numeración chapa 249J. Se necesita la numeración que aparece en el disco de la caja.				
Laredo 4000 gasolina		1999		BT10CT011
Longitud: 75 mm. Transmisión trasera entra en un eje estriado deslizante. Se necesita la numeración que aparece en el disco de la caja.				
Laredo 4,0 gasolina				BT10CT012
1 interruptor (1 de 4 pines). Numeración chapa 249J. Transmisión estriada con corredera. Se necesita la numeración que aparece en el disco de la caja.				
2.7 TD diesel Mercedes		2002		BT10CT014
1 interruptor con 2 pines. Modelos de 2002 a 2005. Se necesita la numeración que aparece en el disco de la caja.				
3.0 V6 TD		2006		BT10CT016
Numeración disco, empieza por 245J. Ratio 2.72. Lleva un adhesivo en la parte de arriba con número NPG45129. Se necesita la numeración que aparece en el disco de la caja.				
2.800		2008-2014		BT10CT017



Sorento

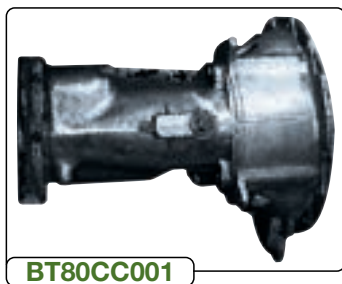

BT80CC001



BT45CC004

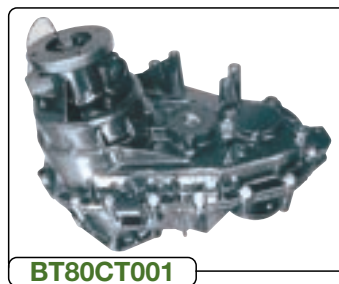

BT80CT001

Cajas de cambio

Modelo	kW/HP	Año	Caja	Referencia
2500 diesel		2004		BT80CC001
2200, 6 velocidades		2010-2015		BT45CC004

Cajas de transfer

Modelo	kW/HP	Año	Caja	Referencia
2500 diesel		2002-12/2004		BT80CT001
Transmisión manual. Con diferencial interno bloqueable electrónico de carácter progresivo. Esta caja incorpora 2 sensores y es RECOMENDABLE cambiarlos, si no la garantía se invalida. Es necesario comunicar numeración en adhesivo BorgWarner o placa lateral.				
2500 diesel		2002-12/2004		BT80CT002
Transmisión automática. Con diferencial interno bloqueable electrónico de carácter progresivo. Esta caja incorpora 2 sensores y es RECOMENDABLE cambiarlos, si no la garantía se invalida. Es necesario comunicar numeración en adhesivo BorgWarner o placa lateral.				
Sorento		2005-		BT80CT003
2 interruptores. Transmisión manual y automática. Con diferencial interno bloqueable electrónico de carácter progresivo. Esta caja incorpora 2 sensores y es RECOMENDABLE cambiarlos, si no la garantía se invalida. Es necesario comunicar numeración en adhesivo BorgWarner o placa lateral.				

Sportage



BT80CC002



BT45CT001



BT45CT002

Cajas de cambio

Modelo	kW/HP	Año	Caja	Referencia
2000 diesel, 5 velocidades		2005		BT80CC002

Cajas de transfer

Modelo	kW/HP	Año	Caja	Referencia
2.0 y 2.2 diesel				BT45CT001
Eje con 3 coronas estriadas. 4 y 5 velocidades.				
2.0 y 2.2 diesel				BT45CT002
Eje con 2 coronas estriadas.				

Navigator (UN173)

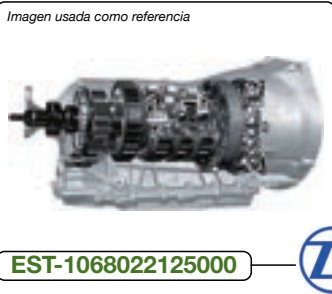

Cajas de cambio automáticas 6 HP 26 X

Modelo	kW/HP	Año	Caja	Referencia
5.4 4WD	224/305	05/1997-12/2002	6AT	EST-1068022125000

Maserati

GHIBLI III (M157)



Cajas de transfer

Modelo	kW/HP	Año	Caja	Referencia
3.0 S Q4	301/409	08/2013-		TT01-21-002

Levante SUV (M161)



Cajas de transfer

Modelo	kW/HP	Año	Caja	Referencia
3,0	257/350	06/2016-		TT01-21-001
3.0 D	184/250	06/2016-		TT01-21-001
3.0 D	202/275	06/2016-		TT01-21-001
3.0 S	316/430	06/2016-		TT01-21-001

Quattroporte VI



Cajas de transfer

Modelo	kW/HP	Año	Caja	Referencia
3.0 S Q4	302/411	05/2013-		TT01-21-002
3.0 S Q4	301/409	11/2016-		TT01-21-002
3.0 S Q4	306/416	05/2013-		TT01-21-002

MAZDA



BT32CC001



BT32CC005



BT32AC002

Cajas de cambio

Modelo	kW/HP	Año	Caja	Referencia
B 2.5 diesel		1998-2006		BT32CC001
B 2500 4x4		2006-2010		BT32CC003
B 2500 4x4, 5 velocidades		2011-		BT32CC004
B 2500 4x4, 6 velocidades		2011-		BT32CC005

Cajas completas (cambio y transfer)

Modelo	kW/HP	Año	Caja	Referencia
B 2.5 diesel		2000-2006		BT32AT001
B 2500, 5 velocidades		2006-2012		BT32AT002

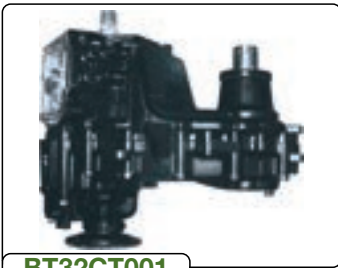

BT32CT001



BT32CT004

Cajas de transfer

Modelo	kW/HP	Año	Caja	Referencia
B		-2006		BT32CT001
B		2006-2010		BT32CT002
B, para caja de 5 velocidades		2011-		BT32CT003
B, para caja de 6 velocidades		2011-		BT32CT004



Clase A (176) W176



TT03-90-001



TT03-90-002

Diferencial trasero

Modelo	kW/HP	Año	Caja	Referencia
(176)02/2014176	100/136	02/2014-		TT03-90-001
(176) W176	125/170	09/2012-		TT03-90-001
(176) W176	130/177	07/2015-		TT03-90-001
(176) W176	135/184	05/2014-		TT03-90-001
(176) W176	155/211	06/2012-06/2015		TT03-90-001
(176) W176	160/218	07/2015-		TT03-90-001
(176) W176	265/360	06/2013-06/2015		TT03-90-002
(176) W176	280/381	07/2015-		TT03-90-002

Clase B (246, 242) W246, W242



TT03-90-001

Diferencial trasero

Modelo	kW/HP	Año	Caja	Referencia
(246, 242) W246, W242	100/136	08/2014-		TT03-90-001
(246, 242) W246, W242	130/177	09/2014-		TT03-90-001
(246, 242) W246, W242	135/184	05/2013-		TT03-90-001
(246, 242) W246, W242	155/211	08/2014-		TT03-90-001

Clase C (203) S203



TT01-90-018

Cajas de transfer

Modelo	kW/HP	Año	Caja	Referencia
(203) S203	125/170	07/2002-08/2007		TT01-90-018
(203) S203	160/218	07/2002-08/2007		TT01-90-018
(203) S203	170/231	01/2005-08/2007		TT01-90-018
(203) S203	200/272	01/2005-08/2007		TT01-90-018

Clase C (203) W203



TT01-90-018

Cajas de transfer

Modelo	kW/HP	Año	Caja	Referencia
(203) W203	125/170	07/2002-02/2007		TT01-90-018
(203) W203	160/218	07/2002-02/2007		TT01-90-018
(203) W203	170/231	01/2005-02/2007		TT01-90-018
(203) W203	200/272	01/2005-02/2007		TT01-90-018

Clase CLA (117) C117



TT03-90-001



TT03-90-002

Diferencial trasero

Modelo	kW/HP	Año	Caja	Referencia
(117) C117	100/136	07/2014-		TT03-90-001
(117) C117	120/163	08/2014-		TT03-90-001
(117) C117	125/170	07/2014-		TT03-90-001
(117) C117	130/177	09/2014-		TT03-90-001
(117) C117	135/184	04/2016-		TT03-90-001
(117) C117	155/211	07/2013-		TT03-90-001
(117) C117	160/218	07/2015-		TT03-90-001
(117) C117	265/360	07/2013-		TT03-90-002
(117) C117	280/381	07/2015-		TT03-90-002

Clase CLA (117) X117



TT03-90-001



TT03-90-002

Diferencial trasero

Modelo	kW/HP	Año	Caja	Referencia
(117) X117	100/136	01/2015-		TT03-90-001
(117) X117	120/163	09/2015-		TT03-90-001
(117) X117	130/177	01/2015-		TT03-90-001
(117) X117	135/184	04/2016-		TT03-90-001
(117) X117	155/211	01/2015-		TT03-90-001
(117) X117	160/218	07/2015-		TT03-90-001
(117) X117	265/360	01/2015-06/2015		TT03-90-002
(117) X117	280/381	07/2015-		TT03-90-002

Clase E (210) S210



TT01-90-019



TT01-90-020

Cajas de transfer

Modelo	kW/HP	Año	Caja	Referencia
(210) S210	150/204	12/1996-12/1999		TT01-90-019
(210) S210	150/204	12/1996-03/2003		TT01-90-020
(210) S210	165/224	12/1996-03/2003		TT01-90-019

Clase E (210) W210



TT01-90-019



TT01-90-020

Cajas de transfer

Modelo	kW/HP	Año	Caja	Referencia
(210) W210	150/204	12/1996-12/1999		TT01-90-019
(210) W210	150/204	01/2000-03/2002		TT01-90-020
(210) W210	160/218	09/1997-12/1998		TT01-90-019
(210) W210	165/224	06/1997-03/2002		TT01-90-019

Clase E (211) S211



TT01-90-017



TT01-90-016



TT01-90-021



TT01-90-018

Cajas de transfer

Modelo	kW/HP	Año	Caja	Referencia
(211) S211	130/177	07/2003-07/2009		TT01-90-018
(211) S211	140/190	03/2005-07/2009		TT01-90-016
(211) S211	165/224	07/2003-07/2009		TT01-90-018
(211) S211	165/224	03/2005-07/2009		TT01-90-016

Cajas de transfer

Modelo	kW/HP	Año	Caja	Referencia
(211) S211	170/231	03/2005-07/2009		TT01-90-021
(211) S211	200/272	03/2005-07/2009		TT01-90-021
(211) S211	225/306	10/2003-07/2009		TT01-90-017
(211) S211	285/388	04/2006-07/2009		TT01-90-016

Clase E (211) W211



TT01-90-017



TT01-90-016



TT01-90-021



TT01-90-018

Cajas de transfer

Modelo	kW/HP	Año	Caja	Referencia
(211) W211	130/177	03/2003-12/2008		TT01-90-018
(211) W211	140/190	03/2005-12/2008		TT01-90-016
(211) W211	165/224	03/2003-12/2008		TT01-90-018
(211) W211	165/224	03/2005-12/2008		TT01-90-016

Cajas de transfer

Modelo	kW/HP	Año	Caja	Referencia
(211) W211	170/231	01/2006-12/2008		TT01-90-021
(211) W211	200/272	03/2005-12/2008		TT01-90-021
(211) W211	225/306	10/2003-12/2008		TT01-90-017
(211) W211	285/388	04/2006-12/2008		TT01-90-016



Clase G (460) W460



TT01-90-001

Cajas de transfer				
Modelo	kW/HP	Año	Caja	Referencia
(460) W460	110/150	08/1984-08/1989		TT01-90-001
(460) W460	110/150	08/1984-08/1989		TT01-90-001
(460) W460	110/150	08/1984-08/1989		TT01-90-001
(460) W460	110/150	08/1984-08/1989		TT01-90-001
(460) W460	110/150	08/1984-08/1989		TT01-90-001
(460) W460	110/150	08/1984-08/1989		TT01-90-001
(460) W460	110/150	08/1984-08/1989		TT01-90-001
(460) W460	53/72	03/1979-08/1987		TT01-90-001
(460) W460	53/72	03/1979-08/1987		TT01-90-001
(460) W460	53/72	03/1979-08/1987		TT01-90-001
(460) W460	53/72	03/1979-08/1987		TT01-90-001
(460) W460	53/72	03/1979-08/1987		TT01-90-001
(460) W460	53/72	03/1979-08/1987		TT01-90-001
(460) W460	53/72	03/1979-08/1987		TT01-90-001
(460) W460	62/84	10/1987-12/1992		TT01-90-001
(460) W460	62/84	10/1987-12/1992		TT01-90-001
(460) W460	62/84	10/1987-12/1992		TT01-90-001
(460) W460	62/84	10/1987-12/1992		TT01-90-001
(460) W460	62/84	10/1987-12/1992		TT01-90-001
(460) W460	62/84	10/1987-12/1992		TT01-90-001
(460) W460	65/88	12/1979-12/1991		TT01-90-001
(460) W460	65/88	12/1979-12/1991		TT01-90-001
(460) W460	65/88	12/1979-12/1991		TT01-90-001

Cajas de transfer				
Modelo	kW/HP	Año	Caja	Referencia
(460) W460	65/88	12/1979-12/1991		TT01-90-001
(460) W460	65/88	12/1979-12/1991		TT01-90-001
(460) W460	65/88	12/1979-12/1991		TT01-90-001
(460) W460	65/88	12/1979-12/1991		TT01-90-001
(460) W460	65/88	12/1979-12/1991		TT01-90-001
(460) W460	75/102	02/1980-07/1987		TT01-90-001
(460) W460	75/102	02/1980-07/1987		TT01-90-001
(460) W460	75/102	02/1980-07/1987		TT01-90-001
(460) W460	75/102	02/1980-07/1987		TT01-90-001
(460) W460	75/102	02/1980-07/1987		TT01-90-001
(460) W460	75/102	02/1980-07/1987		TT01-90-001
(460) W460	75/102	02/1980-07/1987		TT01-90-001
(460) W460	75/102	02/1980-07/1987		TT01-90-001
(460) W460	80/113	01/1980-12/1991		TT01-90-001
(460) W460	80/113	01/1980-12/1991		TT01-90-001
(460) W460	80/113	01/1980-12/1991		TT01-90-001
(460) W460	92/125	01/1980-12/1991		TT01-90-001
(460) W460	92/125	05/1987-08/1992		TT01-90-001
(460) W460	92/125	05/1987-08/1992		TT01-90-001
(460) W460	92/125	05/1987-08/1992		TT01-90-001
(460) W460	92/125	05/1987-08/1992		TT01-90-001
(460) W460	92/125	05/1987-08/1992		TT01-90-001
(460) W460	92/125	05/1987-08/1992		TT01-90-001
(460) W460	92/125	05/1987-08/1992		TT01-90-001
(460) W460	92/125	05/1987-08/1992		TT01-90-001



Clase G (463) W463



TT01-90-001



TT01-90-006



TT01-90-002



TT01-90-003



TT01-90-004



TT01-90-005

Cajas de transfer

Modelo	kW/HP	Año	Caja	Referencia
(463) W463	100/136	01/1992-12/1997		TT01-90-003
(463) W463	100/136	01/1992-12/1997		TT01-90-003
(463) W463	100/136	01/1992-12/1997		TT01-90-003
(463) W463	115/156	10/2001-12/2006		TT01-90-002
(463) W463	115/156	10/2001-12/2006		TT01-90-002
(463) W463	125/170	01/1990-12/1994		TT01-90-003
(463) W463	125/170	01/1990-12/1994		TT01-90-005
(463) W463	125/170	01/1990-12/1994		TT01-90-005
(463) W463	125/170	01/1990-12/1994		TT01-90-005
(463) W463	130/177	08/1996-12/2001		TT01-90-006
(463) W463	130/177	08/1996-12/2001		TT01-90-006
(463) W463	130/177	08/1996-12/2001		TT01-90-006
(463) W463	155/211	07/2011-		TT01-90-002
(463) W463	158/215	09/1994-12/2005		TT01-90-006
(463) W463	158/215	09/1994-12/2005		TT01-90-002
(463) W463	158/215	09/1994-12/2005		TT01-90-002
(463) W463	158/215	09/1994-12/2005		TT01-90-006
(463) W463	158/215	09/1994-12/2005		TT01-90-002
(463) W463	158/215	09/1994-12/2005		TT01-90-006
(463) W463	158/215	09/1994-12/2005		TT01-90-002
(463) W463	158/215	09/1994-12/2005		TT01-90-006
(463) W463	184/250	12/2000-12/2005		TT01-90-002
(463) W463	184/250	12/2000-12/2005		TT01-90-002
(463) W463	184/250	12/2000-12/2005		TT01-90-002
(463) W463	200/272	01/1995-12/1998		TT01-90-003
(463) W463	200/272	01/1995-12/1998		TT01-90-003
(463) W463	200/272	01/1995-12/1998		TT01-90-006
(463) W463	200/272	01/1995-12/1998		TT01-90-006
(463) W463	200/272	01/1995-12/1998		TT01-90-006
(463) W463	200/272	01/1995-12/1998		TT01-90-003
(463) W463	218/296	04/1998-12/2007		TT01-90-002
(463) W463	218/296	04/1998-12/2007		TT01-90-002
(463) W463	218/296	04/1998-12/2007		TT01-90-002

Cajas de transfer

Modelo	kW/HP	Año	Caja	Referencia
(463) W463	218/296	04/1998-12/2007		TT01-90-002
(463) W463	260/354	04/1999-05/2004		TT01-90-006
(463) W463	260/354	04/1999-05/2004		TT01-90-002
(463) W463	260/354	04/1999-05/2004		TT01-90-006
(463) W463	260/354	04/1999-05/2004		TT01-90-006
(463) W463	260/354	04/1999-05/2004		TT01-90-002
(463) W463	285/388	01/2008-		TT01-90-001
(463) W463	285/388	01/2008-		TT01-90-002
(463) W463	350/476	06/2004-07/2006		TT01-90-002
(463) W463	400/544	06/2012-		TT01-90-006
(463) W463	450/612	06/2012-		TT01-90-006
(463) W463	69/94	01/1990-12/1992		TT01-90-005
(463) W463	69/94	01/1990-12/1992		TT01-90-005
(463) W463	69/94	01/1990-12/1992		TT01-90-005
(463) W463	83/113	01/1990-12/1994		TT01-90-004
(463) W463	83/113	01/1990-12/1994		TT01-90-005
(463) W463	83/113	01/1990-12/1994		TT01-90-005
(463) W463	83/113	01/1990-12/1994		TT01-90-004
(463) W463	83/113	01/1990-12/1994		TT01-90-004
(463) W463	83/113	01/1990-12/1994		TT01-90-005
(463) W463	83/113	01/1990-12/1994		TT01-90-005
(463) W463	83/113	01/1990-12/1994		TT01-90-004
(463) W463	83/113	01/1990-12/1994		TT01-90-005
(463) W463	85/116	01/1990-12/1993		TT01-90-005
(463) W463	85/116	01/1990-12/1993		TT01-90-004
(463) W463	85/116	01/1990-12/1993		TT01-90-004
(463) W463	85/116	01/1990-12/1993		TT01-90-005
(463) W463	85/116	01/1990-12/1993		TT01-90-004
(463) W463	85/116	01/1990-12/1993		TT01-90-005
(463) W463	93/126	01/1990-12/1995		TT01-90-004
(463) W463	93/126	01/1990-12/1995		TT01-90-004
(463) W463	93/126	01/1990-12/1995		TT01-90-005
(463) W463	93/126	01/1990-12/1995		TT01-90-004
(463) W463	93/126	01/1990-12/1995		TT01-90-005
(463) W463	93/126	01/1990-12/1995		TT01-90-005

Clase GL (164) X164



TT01-90-011



TT01-90-007



TT01-90-012



TT01-90-008

Cajas de transfer

Modelo	kW/HP	Año	Caja	Referencia
(164) X164	155/211	12/2009-07/2011		TT01-90-008
(164) X164	155/211	12/2009-01/2014		TT01-90-012
(164) X164	165/224	09/2006-05/2009		TT01-90-008
(164) X164	165/224	09/2006-05/2009		TT01-90-012
(164) X164	165/224	05/2009-12/2009		TT01-90-008
(164) X164	165/224	05/2009-01/2014		TT01-90-012
(164) X164	195/265	01/2010-		TT01-90-012
(164) X164	195/265	01/2010-		TT01-90-008
(164) X164	225/306	09/2006-10/2008		TT01-90-007
(164) X164	225/306	09/2006-10/2008		TT01-90-011

Cajas de transfer

Modelo	kW/HP	Año	Caja	Referencia
(164) X164	225/306	10/2008-		TT01-90-012
(164) X164	225/306	10/2008-		TT01-90-008
(164) X164	225/306	05/2009-		TT01-90-012
(164) X164	225/306	05/2009-		TT01-90-008
(164) X164	250/340	09/2006-01/2014		TT01-90-012
(164) X164	250/340	09/2006-		TT01-90-008
(164) X164	285/388	10/2007-		TT01-90-008
(164) X164	285/388	09/2009-07/2010		TT01-90-012

Clase GL (164) X164



TT02-90-001

Diferencial delantero

Modelo	kW/HP	Año	Caja	Referencia
(164) X164	225/306	09/2006-05/2009		TT02-90-001
(164) X164	225/306	05/2009-		TT02-90-001



Clase GLA (166) X166



TT01-90-012



TT01-90-008



TT01-90-010



TT01-90-009

Cajas de transfer				
Modelo	kW/HP	Año	Caja	Referencia
(166) X166	179/243	07/2012-		TT01-90-008
(166) X166	179/243	07/2012-		TT01-90-009
(166) X166	190/258	07/2012-		TT01-90-008
(166) X166	190/258	07/2012-		TT01-90-009
(166) X166	245/333	08/2013-		TT01-90-008
(166) X166	245/333	01/2014-		TT01-90-012
(166) X166	270/367	07/2012-		TT01-90-008
(166) X166	270/367	01/2014-		TT01-90-012

Cajas de transfer				
Modelo	kW/HP	Año	Caja	Referencia
(166) X166	310/422	04/2015-		TT01-90-008
(166) X166	310/422	04/2015-		TT01-90-012
(166) X166	320/435	07/2012-		TT01-90-008
(166) X166	320/435	01/2014-		TT01-90-012
(166) X166	400/544	07/2012-06/2015		TT01-90-010
(166) X166	405/551	07/2012-06/2015		TT01-90-010
(166) X166	410/558	07/2012-06/2015		TT01-90-010

Clase GLA (156) X156



TT03-90-001



TT03-90-002

Diferencial trasero				
Modelo	kW/HP	Año	Caja	Referencia
(156) X156	100/136	12/2013-		TT03-90-001
(156) X156	120/163	12/2013-		TT03-90-001
(156) X156	125/170	12/2013-		TT03-90-001
(156) X156	130/177	07/2015-		TT03-90-001
(156) X156	135/184	04/2015-		TT03-90-001
(156) X156	155/211	12/2013-		TT03-90-001
(156) X156	155/211	04/2015-		TT03-90-001
(156) X156	265/360	05/2014-		TT03-90-002
(156) X156	280/381	07/2015-		TT03-90-002



Clase GLE (166) W166



TT01-90-012



TT01-90-008



TT01-90-010



TT01-90-009

Cajas de transfer

Modelo	kW/HP	Año	Caja	Referencia
(166) W166	150/204	04/2015-		TT01-90-009
(166) W166	150/204	04/2015-		TT01-90-008
(166) W166	190/258	04/2015-		TT01-90-009
(166) W166	190/258	04/2015-		TT01-90-008
(166) W166	200/272	10/2015-		TT01-90-008
(166) W166	200/272	10/2015-		TT01-90-012
(166) W166	225/306	11/2015-		TT01-90-008
(166) W166	225/306	11/2015-		TT01-90-012
(166) W166	245/333	04/2015-		TT01-90-008
(166) W166	245/333	04/2015-		TT01-90-012

Cajas de transfer

Modelo	kW/HP	Año	Caja	Referencia
(166) W166	270/367	10/2015-04/2016		TT01-90-012
(166) W166	270/367	10/2015-04/2016		TT01-90-008
(166) W166	270/367	05/2016-		TT01-90-012
(166) W166	300/408	04/2015-		TT01-90-008
(166) W166	300/408	04/2015-		TT01-90-012
(166) W166	320/435	04/2015-		TT01-90-012
(166) W166	335/456	10/2015-		TT01-90-008
(166) W166	386/525	04/2015-05/2017		TT01-90-010
(166) W166	410/557	04/2015-		TT01-90-010
(166) W166	430/585	01/2014-06/2015		TT01-90-010

Clase GLE (292) C292



TT01-90-010

Cajas de transfer

Modelo	kW/HP	Año	Caja	Referencia
(292) C292	410/557	03/2015-		TT01-90-010
(292) C292	430/585	03/2015-		TT01-90-010

Clase GLE (292) C292



TT01-90-012

Cajas de transfer

Modelo	kW/HP	Año	Caja	Referencia
(292) C292	200/272	09/2015-		TT01-90-012
(292) C292	245/333	03/2015-		TT01-90-012

Clase GLS (166) X166



TT01-90-012



TT01-90-008



TT01-90-010



TT01-90-009

Cajas de transfer				
Modelo	kW/HP	Año	Caja	Referencia
(166) X166	190/258	11/2015-		TT01-90-009
(166) X166	190/258	11/2015-		TT01-90-008
(166) X166	245/333	11/2015-		TT01-90-008
(166) X166	245/333	11/2015-		TT01-90-012
(166) X166	270/367	06/2016-		TT01-90-008
(166) X166	270/367	06/2016-		TT01-90-012

Cajas de transfer				
Modelo	kW/HP	Año	Caja	Referencia
(166) X166	310/422	03/2016-		TT01-90-008
(166) X166	310/422	03/2016-		TT01-90-012
(166) X166	335/456	11/2015-		TT01-90-012
(166) X166	335/456	11/2015-		TT01-90-008
(166) X166	430/585	11/2015-		TT01-90-012

Clase M (163) W163



TT01-90-015

Cajas de transfer				
Modelo	kW/HP	Año	Caja	Referencia
(163) W163	120/163	12/1999-06/2005		TT01-90-015
(163) W163	160/218	02/1998-08/2002		TT01-90-015
(163) W163	180/245	08/2002-06/2005		TT01-90-015
(163) W163	184/250	09/2001-06/2005		TT01-90-015
(163) W163	200/272	02/1998-06/2005		TT01-90-015
(163) W163	215/292	09/2001-06/2005		TT01-90-015
(163) W163	255/347	02/2000-06/2005		TT01-90-015



Clase M (164) W164



TT01-90-011



TT01-90-007



TT01-90-012



TT01-90-008



TT01-90-013



TT01-90-014



TT02-90-001

Cajas de transfer

Modelo	kW/HP	Año	Caja	Referencia
(164) W164	140/190	07/2005-07/2009		TT01-90-012
(164) W164	140/190	07/2005-07/2009		TT01-90-008
(164) W164	140/190	07/2009-12/2011		TT01-90-008
(164) W164	140/190	07/2009-12/2011		TT01-90-012
(164) W164	150/204	02/2010-12/2011		TT01-90-012
(164) W164	150/204	02/2010-12/2011		TT01-90-008
(164) W164	155/211	07/2005-07/2011		TT01-90-012
(164) W164	155/211	09/2009-12/2011		TT01-90-008
(164) W164	155/211	09/2009-12/2011		TT01-90-012
(164) W164	155/211	09/2009-12/2011		TT01-90-012
(164) W164	155/211	09/2009-12/2011		TT01-90-008
(164) W164	165/224	07/2005-07/2009		TT01-90-008
(164) W164	165/224	07/2005-07/2009		TT01-90-012
(164) W164	165/224	07/2009-12/2011		TT01-90-008
(164) W164	165/224	07/2009-12/2011		TT01-90-012
(164) W164	170/231	02/2010-12/2011		TT01-90-012
(164) W164	170/231	02/2010-12/2011		TT01-90-008
(164) W164	170/231	03/2010-01/2014		TT01-90-012
(164) W164	170/231	03/2010-		TT01-90-008
(164) W164	200/272	07/2005-12/2011		TT01-90-012
(164) W164	200/272	07/2005-12/2011		TT01-90-008
(164) W164	200/272	09/2009-12/2011		TT01-90-014
(164) W164	218/296	09/2005-12/2006		TT01-90-012
(164) W164	218/296	09/2005-12/2006		TT01-90-008
(164) W164	225/306	07/2005-12/2011		TT01-90-008
(164) W164	225/306	07/2005-12/2011		TT01-90-012
(164) W164	225/306	02/2006-10/2008		TT01-90-007
(164) W164	225/306	02/2006-10/2008		TT01-90-011
(164) W164	225/306	10/2008-12/2011		TT01-90-012
(164) W164	225/306	10/2008-12/2011		TT01-90-008
(164) W164	225/306	09/2009-12/2011		TT01-90-008
(164) W164	225/306	09/2009-12/2011		TT01-90-012
(164) W164	285/388	12/2007-12/2011		TT01-90-012
(164) W164	285/388	12/2007-12/2011		TT01-90-008
(164) W164	375/510	01/2006-12/2011		TT01-90-013

Diferencial delantero

Modelo	kW/HP	Año	Caja	Referencia
(164) W164	225/306	02/2006-09/2009		TT02-90-001
(164) W164	225/306	09/2009-12/2011		TT02-90-001



Clase M (166) W166



Cajas de transfer				
Modelo	kW/HP	Año	Caja	Referencia
(166) W166	150/204	06/2011-		TT01-90-009
(166) W166	150/204	09/2011-		TT01-90-008
(166) W166	170/231	06/2011-		TT01-90-009
(166) W166	170/231	09/2011-		TT01-90-008
(166) W166	185/252	04/2014-		TT01-90-012
(166) W166	185/252	04/2014-		TT01-90-008
(166) W166	190/258	06/2011-		TT01-90-009
(166) W166	190/258	09/2011-		TT01-90-008
(166) W166	200/272	11/2013-		TT01-90-008
(166) W166	200/272	01/2014-		TT01-90-012

Cajas de transfer				
Modelo	kW/HP	Año	Caja	Referencia
(166) W166	225/306	09/2011-		TT01-90-008
(166) W166	225/306	09/2011-		TT01-90-008
(166) W166	225/306	01/2014-		TT01-90-012
(166) W166	245/333	08/2013-		TT01-90-008
(166) W166	245/333	01/2014-		TT01-90-012
(166) W166	300/408	02/2012-		TT01-90-008
(166) W166	300/408	01/2014-		TT01-90-012
(166) W166	386/525	11/2011-		TT01-90-010
(166) W166	410/558	11/2011-		TT01-90-010

Clase R (251) W251, V251



Cajas de transfer				
Modelo	kW/HP	Año	Caja	Referencia
(251) W251, V251	140/190	10/2009-		TT01-90-012
(251) W251, V251	140/190	10/2009-		TT01-90-012
(251) W251, V251	155/211	10/2009-		TT01-90-012
(251) W251, V251	155/211	10/2009-		TT01-90-012
(251) W251, V251	165/224	10/2009-		TT01-90-012
(251) W251, V251	165/224	10/2009-		TT01-90-012
(251) W251, V251	195/265	08/2010-		TT01-90-012
(251) W251, V251	200/272	01/2006-07/2010		TT01-90-007

Cajas de transfer				
Modelo	kW/HP	Año	Caja	Referencia
(251) W251, V251	200/272	10/2009-		TT01-90-012
(251) W251, V251	200/272	01/2014-		TT01-90-012
(251) W251, V251	225/306	10/2009-		TT01-90-012
(251) W251, V251	225/306	10/2009-		TT01-90-012
(251) W251, V251	245/333	01/2014-		TT01-90-012
(251) W251, V251	285/388	10/2009-		TT01-90-012
(251) W251, V251	375/510	02/2006-		TT01-90-013
(251) W251, V251	170/231	10/2009-		TT01-90-012

Clase S (220) W220



Cajas de transfer				
Modelo	kW/HP	Año	Caja	Referencia
(220) W220	180/245	06/2003-08/2005		TT01-90-017
(220) W220	205/279	09/2002-08/2005		TT01-90-017
(220) W220	225/306	09/2002-08/2005		TT01-90-017

Pajero / Montero / L200 / Pinin



BT15CC001



BT15CC002



BT15CC007



BT15CC009



BT15CT001



BT15CT002



BT15CT012



BT15CT013

Cajas de cambios

Modelo	kW/HP	Año	Caja	Referencia
Superselect				BT15CC001
Caja cambios "Superselect" Mitsubishi (Montero, Pajero) 2.5 diesel (desde 1991 a 1998) y L200 (desde 1997 a 2006). Hierro/aluminio (campana embrague aluminio, parte alta aluminio Montero/Pajero 2500 (a partir de 1991) y L200 (desde 1997 a 2005) (acero/aluminio), y también Montero Sport 2500 diesel (desde 1997). También para Galloper 2500 (1999). Diámetro punta primario 17 mm.				
Montero 3200 diesel				BT15CC002
Aluminio. Todos los modelos. Caja cambios completa con transfer.				
L200 4x4 turbo y no turbo		1985-1997		BT15CC003
Aluminio. También para Pajero 2500 TD (1983 a 1988).				
L200 2500 (sin turbo)		1997-2005		BT15CC004
Aluminio.				
Montero 2.8 turbo diesel		1997-2000		BT15CC005
Aluminio.				
Montero 3000 V6 gasolina		1991-		BT15CC006
Carcasa de hierro.				
IO y Shogun-Pinin gasolina 1800		1996-2004		BT15CC007
Carcasa de aluminio.				
L200 2500 turbo		2006-		BT15CC008
Carcasa de aluminio.				
Outlander 2.2 y 2.3, 6 velocidades				BT15CC009
Carcasa de aluminio.				

Cajas de transfer

Modelo	kW/HP	Año	Caja	Referencia
Montero/Pajero Superselect				BT15CT001
L200		1997-2006		BT15CT002
26 estrías transmisión delantera y 24 estrías transmisión trasera. También sirve para Mitsubishi Sport 2.5 TD y para el Galloper (Galloper II con 2 interruptores), si no es "Superselect".				
Montero/Pajero				BT15CT003
24 estrías transmisión trasera. No "Superselect".				
Montero 3.2 D				BT15CT004
L200		1983-1997		BT15CT005
También Montero -Pajero No "Superselect" (desde 1989 a 1991). 26 estrías transmisión delantera y 24 estrías transmisión trasera. Interruptor 4x4 junto transmisión trasera.				
Montero 2.8 TD		2000		BT15CT006
Para caja cambios BT15CC005.				
Montero IO 1.8 gasolina		2000		BT15CT007
Montero IO 1.8 gasolina		2000		BT15CT008
L200 2.5 Did		2006-		BT15CT009
5 interruptores y palanca 4x4 en el lado derecho.				
Idem BT15CT009 pero para transmisiones automáticas.				
Montero 3.5 gasolina		2002		BT15CT011
Con motor para seleccionar 4x4.				
L200 2.5 Did		2006-2015		BT15CT012
2 interruptores y palanca 4x4 en el lado derecho.				
L200 2.5 Did		2006-2015		BT15CT013
5 interruptores y palanca 4x4 en el lado derecho.				

Armada



TT01-50-001

Cajas de transfer

Modelo	kW/HP	Año	Caja	Referencia
5.6 4x4	236/321	09/2006-12/2015	7AT	TT01-50-001
5.6 4x4	291/396	05/2016-	7AT	TT01-50-001

Navara



BT35CC009



BT35CT001

Cajas de cambio

Modelo	kW/HP	Año	Caja	Referencia
D22		1998-2000		BT35CC006
Pick-up 2.5 diesel 2x4				BT35CC004
Tapón vaciado aceite lado izquierdo.				
Navara y Pick-up		2000-2005		BT35CC007
Caja de cambios de 5 velocidades. Longitud parte visible del primario: 125 mm.				
Navara y Pick-up		2000-2005		BT35CC008
Caja de cambios de 5 velocidades. Longitud parte visible del primario: 95 mm.				
2.5 turbo diesel, 6 vel.		2006-		BT35CC009
2.5 turbo diesel, 6 vel.		2010-		BT35CC014
Navara / Pick-up NP300		2018		BT35CC017
Modelos de 6 velocidades con motores 2.3. Operado por cable.				
Navara / Pick-up NP300		2015		BT35CC018
Modelos de 6 velocidades con motores 2.3. Palanca cambios.				
Navara / Pick-up NP300		2015		BT35CC019
Modelos de 6 velocidades con motores 2.3. Palanca cambios.				

Cajas de transfer

Modelo	kW/HP	Año	Caja	Referencia
2.5 diesel		2000-2004		BT35CT001
Para caja T35CC002.				
Navara, cambios de 5 vel.		-2014		BT35CT009
Navara, cambios de 6 vel.		2015-2023		BT35CT010
Navara		2004-		BT35CT002
6 velocidades en caja cambios manual y aluminio. Motor eléctrico para conectar el 4x4.				



Pathfinder



BT35CC009



TT01-50-001

Cajas de cambio

Modelo	kW/HP	Año	Caja	Referencia
2.5 TD, 6 velocidades		2006-		BT35CC009
2.5 TD, 6 velocidades		2010-		BT35CC014

Cajas de transfer

Modelo	kW/HP	Año	Caja	Referencia
3.0 TD V6	170/231	05/2010-	7A	TT01-50-001
3.0 dCi	170/231	08/2010-	6MT	TT01-50-001

Patrol



BT35CC009



TT01-50-001



TT01-50-002

Cajas de cambio

Modelo	kW/HP	Año	Caja	Referencia
2.8 (GR) turbo diesel		1987-1996		BT35CC003
Aluminio. Longitud parte visible del primario: 88-92 mm. Estrías primario: 24. Estrías secundario: 30.				
3.0 y 2.8 turbo diesel		1997-		BT35CC005
Aluminio. Longitud parte visible del primario: 110 mm. Estrías primario: 24. Estrías secundario: 30.				
TD27 (2700 cc)				BT35CC011
Longitud parte visible del primario: 95 mm. Estrías primario: 24. Estrías secundario 30.				

Caja de cambio completa

Modelo	kW/HP	Año	Caja	Referencia
2.8 diesel		1994		BT35CC011
Longitud parte visible primario: 95 mm. Tapa primario: 65 mm. Total desde caja cambios: 160 mm.				

Cajas de transfer

Modelo	kW/HP	Año	Caja	Referencia
2800 TD		-1998		BT35CT005
Sin freno de la transmisión en salida transfer.				
GR 3000				BT35CT004
5.6 NISMO	315/428	10/2016-	7AT	TT01-50-001
5.6 V8	294/400	03/2010-	7A	TT01-50-001
5,6	233/317	04/2010-	7AT	TT01-50-002
5,6	233/317	04/2010-	7AT	TT01-50-001
5,6	293/398	12/2010-	7AT	TT01-50-001
5,6	298/405	04/2010-	7AT	TT01-50-001

Qashqai

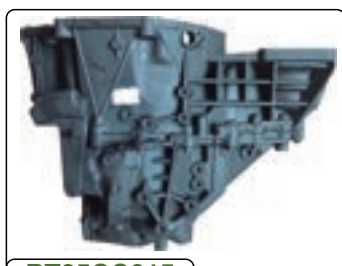

BT35CC015

Cajas de cambio

Modelo	kW/HP	Año	Caja	Referencia
1.6 TD, 6 velocidades		2013-2017		BT35CC015

Terrano



BT35CC001



BT35CC002



BT35CT001

Cajas de cambio

Modelo	kW/HP	Año	Caja	Referencia
SI 2.7 TD y SII 2700 D		1993-1998		BT35CC001
Diámetro secundario: 25 mm. Tapón llenado aceite lado izquierdo. Longitud primario parte visible: 105 mm. Longitud parte estriada: 50 mm. Estrías primario: 24, diámetro: 21,30 mm. Diámetro punta primario: 15,90 mm. También para Nissan Pick-up D21 4x4.				
2700 TDI y 3000 diesel		1999-		BT35CC002
Potencia 125 CV. Diámetro secundario (eje balader): 32 mm. Longitud parte visible primario: 95 mm. Estrías primario: 24. Estrías secundario: 30. Tapón vaciado aceite lado derecho.				

Cajas de transfer

Modelo	kW/HP	Año	Caja	Referencia
SII 2.7 TDI		2004		BT35CT001
Para caja BT35CC002.				
SI y SII				BT35CT003
Para caja BT35CC001.				

X-Trail



BT35CC010

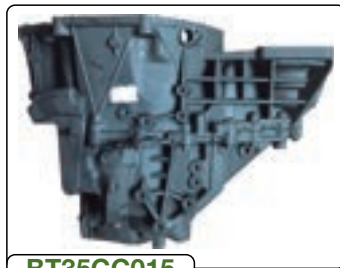

BT35CC015

Cajas de cambio

Modelo	kW/HP	Año	Caja	Referencia
2.2 DCI, 6 velocidades		2006		BT35CC010
Carcasa aluminio.				
2.0 DCI, 6 velocidades		2008-		BT35CC012
Carcasa aluminio.				
1.6 TD, 6 velocidades		2013-2017		BT35CC015

Cajas de transfer

Modelo	kW/HP	Año	Caja	Referencia
2200 cc		2002		BT35CT006
Para caja cambios de 5 velocidades.				
2200 cc		2005		BT35CT007
Para caja cambios de 6 velocidades.				



Monterey



BT25AT002

Cajas de cambio

Modelo	kW/HP	Año	Caja	Referencia
3000 diesel		2000		BT30AT001
Caja cambios y transfer. También para Isuzu Trooper.				
3100 diesel		1994		BT25AT002

Frontera



FOTO
NO DISPONIBLE

BT12CC014

Cajas de cambioBT

Modelo	kW/HP	Año	Caja	Referencia
2800 diesel		1996-2000		BT25AT001
2.2 diesel				BT25AT003
Palanca embrague derecha.				
2.2 diesel				BT25AT004
Palanca embrague izquierda.				



Porsche Cayenne (92A)



TT01-95-006



TT01-95-007



TT01-95-008



TT01-95-016



TT01-95-023



TT01-95-015



TT01-95-009



TT01-95-027



TT01-95-025



TT01-95-026



TT01-95-028

Cajas de transfer

Modelo	kW/HP	Año	Caja	Referencia
3.0 Diesel	155/211	06/2010-	8DCT	TT01-95-016
3.0 Diesel	176/239	06/2010-	8DCT	TT01-95-016
3.0 Diesel	180/245	06/2011-	8DCT	TT01-95-016
3.0 Diesel	184/250	08/2014-	8DCT	TT01-95-016
3.0 Diesel	193/262	10/2014-	8DCT	TT01-95-016
3.0 Diesel	245/333	09/2014-	8DCT	TT01-95-015
3.0 S E-Hybrid	245/333	06/2010-	8DCT	TT01-95-015
3.0 S E-Hybrid	306/416	10/2014-	8DCT	TT01-95-015
3.0 S	245/333	04/2011-	8DCT	TT01-95-023
3.6 GTS	324/440	02/2015-	8DCT	TT01-95-025
3.6 S	309/420	10/2014-	8DCT	TT01-95-025
3,6	220/300	06/2010-12/2014	8DCT	TT01-95-008

Cajas de transfer

Modelo	kW/HP	Año	Caja	Referencia
3,6	220/300	06/2010-12/2014	6MT	TT01-95-007
3,6	220/300	01/2015-	8DCT	TT01-95-028
3,6	224/305	10/2014-	8DCT	TT01-95-028
4.2 S Diesel	281/382	10/2012-05/2014	8DCT	TT01-95-009
4.2 S Diesel	283/385	10/2014-	8DCT	TT01-95-026
4.8 GTS	309/420	06/2012-12/2014	8DCT	TT01-95-006
4.8 S	294/400	06/2010-05/2014	8DCT	TT01-95-006
4.8 Turbo S	405/550	10/2012-12/2014	8DCT	TT01-95-006
4.8 Turbo S	419/570	01/2015-	8DCT	TT01-95-027
4.8 Turbo	368/500	06/2010-05/2014	8DCT	TT01-95-006
4.8 Turbo	382/520	10/2014-	8DCT	TT01-95-027
4.8 Turbo	397/540	06/2010-05/2014	8DCT	TT01-95-006

Porsche Cayenne (9PA)



TT01-95-001



TT01-95-004



TT01-95-005



TT01-95-013

Cajas de transfer

Modelo	kW/HP	Año	Caja	Referencia
3.0 TDI	176/240	02/2009-09/2010	6AT	TT01-95-013
3,2	177/241	08/2003-09/2007	6MT	TT01-95-005
3,2	184/250	10/2003-09/2007	6MT	TT01-95-005
3,6	213/290	02/2007-09/2010	6MT	TT01-95-005
GTS 4.8	298/405	10/2007-09/2010	6AT	TT01-95-001
GTS 4.8	298/405	10/2007-09/2010	6MT	TT01-95-004
S 4.5	184/250	09/2002-12/2006	6MT	TT01-95-004
S 4.5	184/250	09/2002-12/2006	6AT	TT01-95-001
S 4.5	250/340	09/2002-09/2007	6MT	TT01-95-004
S 4.5	250/340	09/2002-09/2007	6AT	TT01-95-001

Cajas de transfer

Modelo	kW/HP	Año	Caja	Referencia
S 4.8	283/385	02/2007-09/2010	6AT	TT01-95-001
S 4.8	283/385	02/2007-09/2010	6MT	TT01-95-004
Turbo 4.5	331/450	09/2002-09/2007	6AT	TT01-95-001
Turbo 4.8	373/507	09/2007-12/2009	6AT	TT01-95-001
Turbo S 4.5	368/500	01/2004-09/2007	6AT	TT01-95-001
Turbo S 4.5	383/521	03/2006-09/2007	6AT	TT01-95-001
Turbo S 4.8	368/500	02/2007-09/2010	6AT	TT01-95-001
Turbo S 4.8	397/540	02/2007-09/2010	6AT	TT01-95-001
Turbo S 4.8	404/550	08/2008-09/2010	6AT	TT01-95-001

Porsche Panamera (970)



TT02-95-003

Diferencial delantero

Modelo	kW/HP	Año	Caja	Referencia
3.0 4S	235/320	10/2013-10/2016	7AT	TT02-95-003
3.0 4S	309/420	07/2013-10/2016	7AT	TT02-95-003
4.8 4S	294/400	09/2009-07/2013	7AT	TT02-95-003
4.8 4S	294/400	09/2009-07/2013	6MT	TT02-95-003
4.8 4S	302/411	09/2009-07/2013	7AT	TT02-95-003
4.8 GTS	316/430	01/2012-07/2013	7AT	TT02-95-003
4.8 GTS	324/440	07/2013-10/2016	7AT	TT02-95-003





Koleos



BT33CT001

Cajas de transfer				
Modelo	kW/HP	Año	Caja	Referencia
1995 cc, 4 cil.	127	2008		BT33CT001

Scénic I Monospace (JA0/1_, FA0_)



BT12CC014

Diferencial				
Modelo	kW/HP	Año	Caja	Referencia
1.9 dCi RX4	74/101	12/2002-08/2003	6AT	TT03-33-001
1.9 dCi RX4	75/102	11/2000-08/2003	6AT	TT03-33-001
2.0 16V RX4	102/139	06/2000-08/2003	6AT	TT03-33-001

Rolls-Royce



Phantom VII (RR1)

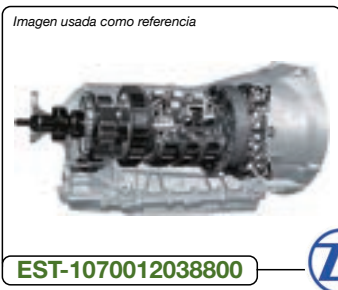

EST-1070012038800

Cajas de cambio automáticas 6 HP 32				
Modelo	kW/HP	Año	Caja	Referencia
V12	338/460	01/2003-07/2017	6AT	EST-1070012038800



Seat Alhambra (7V8, 7V9)



TT03-95-022

Diferencial trasero

Modelo	kW/HP	Año	Caja	Referencia
1.9 TDI 4motion	85/115	06/2000-03/2010	6MT	TT03-95-022
2.8 V6 4motion	150/204	06/2000-03/2010	6MT	TT03-95-022

Seat Altea XL (5P5, 5P8)



TT02-95-006

Diferencial delantero

Modelo	kW/HP	Año	Caja	Referencia
2.0 TDI 16V 4x4	103/140	10/2010-	6MT	TT02-95-006
2.0 TDI 4x4	103/140	06/2007-	6MT	TT02-95-006
2.0 TDI 4x4	125/170	06/2007-	6MT	TT02-95-006
2.0 TFSI 4x4	147/200	06/2007-05/2009	6AT	TT02-95-006
2.0 TFSI 4x4	155/211	05/2009-	6AT	TT02-95-006



TT03-95-006



TT03-95-008

Diferencial trasero

Modelo	kW/HP	Año	Caja	Referencia
2.0 TDI 16V 4x4	103/140	10/2010-	6MT	TT03-95-008
2.0 TDI 4x4	103/140	06/2007-03/2010	6MT	TT03-95-006
2.0 TDI 4x4	103/140	03/2010-	6MT	TT03-95-008
2.0 TDI 4x4	125/170	06/2007-03/2010	6MT	TT03-95-006
2.0 TDI 4x4	125/170	03/2010-	6MT	TT03-95-008
2.0 TFSI 4x4	147/200	06/2007-05/2009	6AT	TT03-95-005
2.0 TFSI 4x4	155/211	05/2009-03/2010	6AT	TT03-95-006
2.0 TFSI 4x4	155/211	03/2010-	6AT	TT03-95-008

Seat León (1M1)



TT03-95-016



TT03-95-017

Diferencial trasero

Modelo	kW/HP	Año	Caja	Referencia
1.8 20V T 4	132/180	11/1999-06/2006	6MT	TT03-95-016
1.8 Turbo 4x4	154/209	05/2002-05/2003	6MT	TT03-95-016
1.9 TDI 4x4	110/150	05/2002-06/2006	6MT	TT03-95-017
2.8 Cupra 4	150/204	02/2001-06/2006	6MT	TT03-95-016

Skoda Octavia (1U2)



TT02-95-016

Diferencial delantero

Modelo	kW/HP	Año	Caja	Referencia
1.8 T 4x4	110/150	05/2001-05/2006	5MT	TT02-95-016

Skoda Octavia Station Wagon (1U5)



TT02-95-016

Diferencial delantero

Modelo	kW/HP	Año	Caja	Referencia
1.8 T 4x4	110/150	05/2001-05/2006	5MT	TT02-95-016



TT03-95-017

Diferencial trasero

Modelo	kW/HP	Año	Caja	Referencia
1.9 TDI 4x4	74/100	09/2000-01/2006	6MT	TT03-95-017

Skoda Octavia Station wagon (1Z5)



TT02-95-013



TT02-95-006

Diferencial delantero

Modelo	kW/HP	Año	Caja	Referencia
1.6 TDI 4x4	77/105	06/2009-02/2013	6MT	TT02-95-006
1.8 TSI 4x4	112/152	03/2009-02/2013	6MT	TT02-95-006
1.8 TSI 4x4	118/160	11/2008-02/2013	6MT	TT02-95-006
1.9 TDI 4x4	77/105	11/2004-12/2010	6MT	TT02-95-006
2.0 FSI 4x4	110/150	11/2004-10/2008	6MT	TT02-95-013
2.0 TDI 16V 4x4	103/140	05/2010-02/2013	6MT	TT02-95-006
2.0 TDI 4x4	103/140	07/2006-05/2010	6MT	TT02-95-006
2.0 TDI 4x4	81/110	05/2011-02/2013	6MT	TT02-95-006

Skoda Octavia Station wagon (1Z5)



TT03-95-005



TT03-95-008

Diferencial trasero

Modelo	kW/HP	Año	Caja	Referencia
1.6 TDI 4x4	77/105	06/2009-02/2013	6MT	TT03-95-008
1.8 TSI 4x4	112/152	03/2009-02/2013	6MT	TT03-95-008
1.8 TSI 4x4	118/160	11/2008-02/2013	6MT	TT03-95-008
1.9 TDI 4x4	77/105	11/2004-10/2008	6MT	TT03-95-005
1.9 TDI 4x4	77/105	11/2008-12/2010	6MT	TT03-95-008
2.0 FSI 4x4	110/150	11/2004-10/2008	6MT	TT03-95-005
2.0 TDI 16V 4x4	103/140	05/2010-02/2013	6MT	TT03-95-008
2.0 TDI 4x4	103/140	07/2006-10/2008	6MT	TT03-95-005
2.0 TDI 4x4	103/140	11/2008-05/2010	6MT	TT03-95-008
2.0 TDI 4x4	81/110	05/2011-02/2013	6MT	TT03-95-008

Skoda Superb (3T4)



TT02-95-006



TT02-95-007

Diferencial delantero

Modelo	kW/HP	Año	Caja	Referencia
1.8 TSI 4x4	112/152	03/2009-05/2015	6MT	TT02-95-006
1.8 TSI 4x4	118/160	11/2008-05/2015	6MT	TT02-95-006
2.0 TDI 16V 4x4	103/140	11/2010-05/2015	6AT	TT02-95-007
2.0 TDI 16V 4x4	103/140	11/2010-05/2015	6MT	TT02-95-006
2.0 TDI 4x4	125/170	09/2008-05/2015	6MT	TT02-95-006
2.0 TDI 4x4	125/170	09/2008-05/2015	6AT	TT02-95-007
3.6 FSI 4x4	191/260	11/2008-05/2015	6AT	TT02-95-007



TT03-95-008

Diferencial trasero

Modelo	kW/HP	Año	Caja	Referencia
1.8 TSI 4x4	112/152	03/2009-05/2015	6MT	TT03-95-008
1.8 TSI 4x4	118/160	11/2008-05/2015	6MT	TT03-95-008
2.0 TDI 16V 4x4	103/140	11/2010-05/2015	6AT	TT03-95-008
2.0 TDI 16V 4x4	103/140	11/2010-05/2015	6MT	TT03-95-008
2.0 TDI 4x4	125/170	09/2008-05/2015	6MT	TT03-95-008
2.0 TDI 4x4	125/170	09/2008-05/2015	6AT	TT03-95-008
3.6 FSI 4x4	191/260	11/2008-05/2015	6AT	TT03-95-008



Skoda Superb Station wagon (3T5)



TT02-95-006



TT02-95-007



TT03-95-008

Diferencial delantero

Modelo	kW/HP	Año	Caja	Referencia
1.8 TSI 4x4	112/152	10/2009-05/2015	6MT	TT02-95-006
1.8 TSI 4x4	118/160	10/2009-05/2015	6AT	TT02-95-007
1.8 TSI 4x4	118/160	10/2009-05/2015	6MT	TT02-95-006
2.0 TDI 16V 4x4	103/140	11/2010-05/2015	6AT	TT02-95-007
2.0 TDI 16V 4x4	103/140	11/2010-05/2015	6MT	TT02-95-006
2.0 TDI 4x4	125/170	10/2009-05/2015	6AT	TT02-95-007
2.0 TDI 4x4	125/170	10/2009-05/2015	6MT	TT02-95-006
3.6 V6 4x4	191/260	10/2009-05/2015	6AT	TT02-95-007

Diferencial trasero

Modelo	kW/HP	Año	Caja	Referencia
1.8 TSI 4x4	112/152	10/2009-05/2015	6MT	TT03-95-008
1.8 TSI 4x4	118/160	10/2009-05/2015	6AT	TT03-95-008
1.8 TSI 4x4	118/160	10/2009-05/2015	6MT	TT03-95-008
2.0 TDI 16V 4x4	103/140	11/2010-05/2015	6MT	TT03-95-008
2.0 TDI 16V 4x4	103/140	11/2010-05/2015	6AT	TT03-95-008
2.0 TDI 4x4	125/170	10/2009-05/2015	6AT	TT03-95-008
2.0 TDI 4x4	125/170	10/2009-05/2015	6MT	TT03-95-008
3.6 V6 4x4	191/260	10/2009-05/2015	6AT	TT03-95-008

Skoda Yeti (5L)



TT02-95-006



TT02-95-007



TT03-95-008



TT03-95-010

Diferencial delantero

Modelo	kW/HP	Año	Caja	Referencia
1.4 TSI 4x4	110/150	05/2015-	6MT	TT02-95-006
1.4 TSI 4x4	110/150	05/2015-	6DCT	TT02-95-007
1.8 TSI 4x4	112/152	11/2009-	6DCT	TT02-95-007
1.8 TSI 4x4	118/160	05/2009-	6MT	TT02-95-006
2.0 TDI 4x4	103/140	05/2009-	6DCT	TT02-95-007
2.0 TDI 4x4	103/140	05/2009-	6MT	TT02-95-006
2.0 TDI 4x4	110/150	05/2015-	6DCT	TT02-95-007
2.0 TDI 4x4	110/150	05/2015-	6MT	TT02-95-006
2.0 TDI 4x4	125/170	11/2009-	6DCT	TT02-95-007
2.0 TDI 4x4	125/170	11/2009-	6MT	TT02-95-006
2.0 TDI 4x4	81/110	11/2009-	6MT	TT02-95-006

Diferencial trasero

Modelo	kW/HP	Año	Caja	Referencia
1.4 TSI 4x4	110/150	05/2015-	6MT	TT03-95-010
1.4 TSI 4x4	110/150	05/2015-	6DCT	TT03-95-010
1.8 TSI 4x4	112/152	11/2009-12/2013	6DCT	TT03-95-008
1.8 TSI 4x4	112/152	01/2014-	6DCT	TT03-95-010
1.8 TSI 4x4	118/160	05/2009-12/2013	6MT	TT03-95-008
1.8 TSI 4x4	118/160	01/2014-	6MT	TT03-95-010
2.0 TDI 4x4	103/140	05/2009-12/2013	6MT	TT03-95-008
2.0 TDI 4x4	103/140	05/2009-12/2013	6DCT	TT03-95-008
2.0 TDI 4x4	103/140	01/2014-	6DCT	TT03-95-010
2.0 TDI 4x4	103/140	01/2014-	6MT	TT03-95-010
2.0 TDI 4x4	110/150	05/2015-	6MT	TT03-95-010
2.0 TDI 4x4	110/150	05/2015-	6DCT	TT03-95-010
2.0 TDI 4x4	125/170	11/2009-12/2013	6MT	TT03-95-008
2.0 TDI 4x4	125/170	11/2009-12/2013	6DCT	TT03-95-008
2.0 TDI 4x4	125/170	01/2014-	6MT	TT03-95-010
2.0 TDI 4x4	125/170	01/2014-	6DCT	TT03-95-010
2.0 TDI 4x4	81/110	11/2009-12/2013	6MT	TT03-95-008
2.0 TDI 4x4	81/110	01/2014-	6MT	TT03-95-010

Legacy e Impreza



BT42CC001

Caja de cambios completa (incluye transfer)

Modelo	kW/HP	Año	Caja	Referencia
Legacy e Impreza				BT42CC001



Tipo 1



FOTO
NO DISPONIBLE

BT12CC014

Cajas de cambio

Modelo	kW/HP	Año	Caja	Referencia
Tipo 1 (Bosch)				BT12CC014

Diámetro punta primario: 10 mm, diámetro sobre estría: 22, número de estrías: 20, estrías secundario 23. Embrague por cable.

Samurai



BT12CC001



BT12CT001

Cajas de cambio

Modelo	kW/HP	Año	Caja	Referencia
SJ410				BT12CC005
Campana embrague redonda.				
SJ413 gasolina, 5 velocidades				BT12CC001
1.9 TD motor PSA				BT12CC008
Eje de entrada 20 estrías, diámetro sobre estría: 22, diámetro punta primario: 10 mm.				

Cajas de transfer

Modelo	kW/HP	Año	Caja	Referencia
SJ413				BT12CT001
Para Samurai moderno también cambiando las bridas.				
También Samurai diesel 1900. Para SJ410: sólo si es 5 velocidades.				

Samurai



BT12CC001



BT12CT001

Cajas de cambio

Modelo	kW/HP	Año	Caja	Referencia
SJ410				BT12CC005
Campana embrague redonda.				
SJ413 gasolina, 5 velocidades				BT12CC001
1.9 TD motor PSA				BT12CC008
Eje de entrada 20 estrías, diámetro sobre estría: 22, diámetro punta primario: 10 mm.				

Cajas de transfer

Modelo	kW/HP	Año	Caja	Referencia
SJ413				BT12CT001
Para Samurai moderno también cambiando las bridas. También Samurai diesel 1900. Para SJ410: sólo si es 5 velocidades.				

Vitara



BT12CC003



BT12CT002



BT12CT003

Cajas de cambio

Modelo	kW/HP	Año	Caja	Referencia
1900 turbo diesel		1998		BT12CC002
Motor Mazda. Diámetro punta primario: 15 mm, sobre estría: 28 mm, estrías: 21 primario y 21 secundario.				
HDI, motor PSA y Santana 350 y 300) y 1600 gasolina				BT12CC003
Centralita Siemens. Diámetro punta primario: 10 mm, diámetro sobre estría: 22, número de estrías: 20, estrías secundario 23. Embrague por cable.				
Vitara con motor Renault		2005-		BT12CC009
Vitara HDI		2002-		BT12AT003
Caja cambios nueva completa (incluye transfer Siemens).				

Cajas de transfer

Modelo	kW/HP	Año	Caja	Referencia
2000 HDI y 1900 TD		2001		BT12CT002
Número de estrías eje trasero salida a transmisión: 16 estrías.				
2000 HDI con motor Mazda		1990-2001		BT12CT003
Número de estrías eje trasero salida a transmisión: 18 estrías.				
1.6 gasolina y 1900 turbo diesel				BT12CT006
Con 26 estrías en la salida de la transmisión trasera.				



Grand Vitara



BT12CT002



BT12CT003

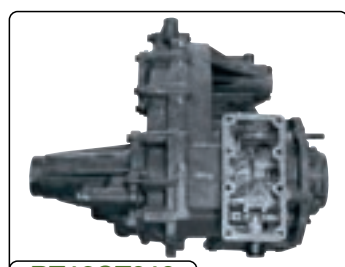

BT12CT010

Cajas de transfer

Modelo	kW/HP	Año	Caja	Referencia
4x2				BT12CT011
4x4 permanente				BT12CT009
4x4				BT12CT010
Con opción selección H/L por pulsador en tablero. Para cambio manual.				
1.9 DDIS motor Renault				BT12CT014
Con motor eléctrico para seleccionar 4x4 y H/L.				
1.9 DDIS motor Renault 4x4 automático				BT12CT015
Sin opción high/low.				
2000 HDI y 1900 TD		2001		BT12CT002
Número de estrías eje trasero salida a transmisión: 16 estrías.				
2000 HDI con motor Mazda		1990-2001		BT12CT003
Número de estrías eje trasero salida a transmisión: 18 estrías.				
2000 turbo diesel		2001-2005		BT12CT007
Con 18 estrías en brida salida transmisión trasera.				

Jimny



BT12CC006

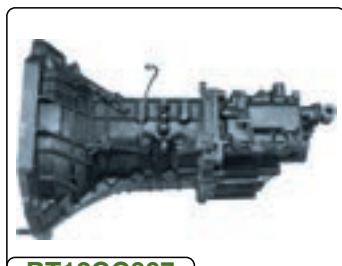

BT12CC007



BT12CT008

Cajas de cambio

Modelo	kW/HP	Año	Caja	Referencia
1300 gasolina		-2005		BT12CC006
Caja con carcasa entera.				
1300 gasolina motores M13A		2005-2018		BT12CC007
Caja con carcasa partida.				

Cajas de transfer

Modelo	kW/HP	Año	Caja	Referencia
4x4		2005-		BT12CT005
Operado mediante motor eléctrico, no palancas. NO incluye el motor.				
4x4 motores gasolina		1999-2005		BT12CT008
Operado mediante palanca.				
4x4 motores diesel		1999-2005		29000A84A00
Operado mediante palanca.				

SX4



FOTO
NO DISPONIBLE

BT12CT012

Cajas de transfer

Modelo	kW/HP	Año	Caja	Referencia
1900 cc		2006		BT12CT012

Hilux



BT22CC006



BT22CC012

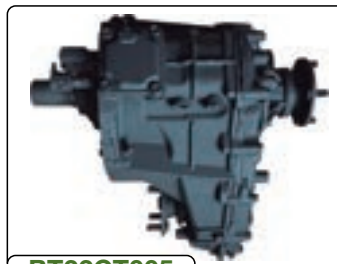

BT22CT005

Cajas de cambio

Modelo	kW/HP	Año	Caja	Referencia
Diesel y gasolina		1985-1997		BT22CC001
Diesel y gasolina		1998-2000		BT22CC003
Interruptor de marcha atrás en el lado izquierdo.				
3000 diesel		2000-2005		BT22CC006
Interruptor de marcha atrás en el lado del pasajero, lado derecho.				
2500 y 3000 D4D		2005-		BT22CC012
Aluminio. Interruptor marcha atrás lado derecho.				

Cajas de transfer

Modelo	kW/HP	Año	Caja	Referencia
Hilux		2006-2015		BT22CT005

Land Cruiser



BT22AT001



BT22CT006

Cajas de cambio

Modelo	kW/HP	Año	Caja	Referencia
Interruptor de marcha atrás a la derecha				BT22CC002
2.5 diesel		1996		BT22CC004
Carcasa de aluminio.				
3125 gasolina		1996		BT22CC005
Carcasa de aluminio.				
2.5 diesel		2003		BT22CC012

Caja de cambio completa (incluye transfer)

Modelo	kW/HP	Año	Caja	Referencia
BJ46 3000 diesel		1983		BT22AT001
5 velocidades.				

Cajas de transfer

Modelo	kW/HP	Año	Caja	Referencia
3.0 turbo diesel		1996-2005		BT22CT001
Para cambio manual y sistema palanca para altas y bajas (es 4x4 permanente con dif. central bloqueable).				
3.0 turbo diesel		1996-2004		BT22CT002
Para cambio manual y sistema palanca y MOTOR (normal 4x4 al accionar el motor).				
3.0 turbo diesel		2004-2010		BT22CT006
Cambio 5 velocidades.				

4 Runner



FOTO
NO DISPONIBLE

BT22CC008

Cajas de cambio

Modelo	kW/HP	Año	Caja	Referencia
2.4 TD y 3.0 TD		1991-1997		BT22CC008

RAV4



FOTO
NO DISPONIBLE

BT22CC010



FOTO
NO DISPONIBLE

BT22CT003

Cajas de cambio

Modelo	kW/HP	Año	Caja	Referencia
2.200 TD, 6 velocidades		2006-		BT22CC010

Cajas de transfer

Modelo	kW/HP	Año	Caja	Referencia
2000 diesel		2004		BT22CT003
2.200 TD		2005-		BT22CT004
Caja cambios de 6 velocidades.				

Ssangyong

Korando



BT43CT001

Cajas de cambio

Modelo	kW/HP	Año	Caja	Referencia
2.9 diesel		1998		BT43CC002
Operada por palancas.				
2.9 diesel		1998		BT43CC004
Operada por cable.				
2.9 diesel		1998		BT43CC005
Operada por palancas.				

Cajas de transfer

Modelo	kW/HP	Año	Caja	Referencia
Diesel		-2001		BT43CT001
Caja cambios aluminio y cambio manual, y automático.				
KJ 2300 TD		2001-		BT43CT002
Motor Mercedes. Carcasa cambio de aluminio. Automático.				

Muso



BT43CC001



BT43CT001

Cajas de cambio

Modelo	kW/HP	Año	Caja	Referencia
2.9 turbo diesel		1998		BT43CC001
Operado por cable, carcasa aluminio.				
2.9 diesel		1998		BT43CC004
Operada por cable.				

Cajas de transfer

Modelo	kW/HP	Año	Caja	Referencia
Diesel		-2001		BT43CT001
Caja cambios aluminio y cambio manual, y automático.				
KJ 2300 TD		2001-		BT43CT002
Motor Mercedes. Carcasa cambio de aluminio. Automático.				

Rexton y Terracan

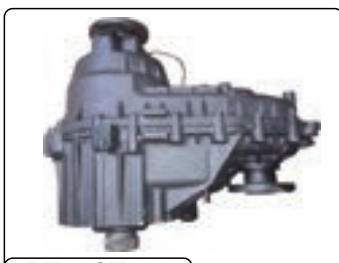

BT43CT003

Cajas de transfer

Modelo	kW/HP	Año	Caja	Referencia
Rexton 2.7 y Terracan				BT43CT003



Volvo



XC90 I (275)



FOTO
NO DISPONIBLE

TT03-54-001

Diferencial trasero

Modelo	kW/HP	Año	Caja	Referencia
2.5 T AWD	154/209	10/2002-09/2014	6AT	TT03-54-001
D5 AWD	120/163	10/2002-12/2006	6AT	TT03-54-001
T6 AWD	200/272	10/2002-12/2006	6AT	TT03-54-001

VW Amarok



TT01-95-024

Cajas de transfer

Modelo	kW/HP	Año	Caja	Referencia
2.0 BiTDI 4motion	120/163	09/2010-	8AT	TT01-95-024
2.0 BiTDI 4motion	120/163	09/2010-	6MT	TT01-95-024
2.0 BiTDI 4motion	132/180	11/2011-	6MT	TT01-95-024
2.0 BiTDI 4motion	132/180	11/2011-	8AT	TT01-95-024
2.0 TDI 4motion	103/140	06/2012-	6MT	TT01-95-024
2.0 TDI 4motion	90/122	09/2010-	6MT	TT01-95-024
2.0 TDI 4motion	90/122	09/2010-	6MT	TT01-95-024
2.0 TSI 4motion	118/160	09/2011-	6MT	TT01-95-024
3.0 TDI 4motion	120/163	06/2016-	6MT	TT01-95-024
3.0 TDI 4motion	150/204	06/2016-	6MT	TT01-95-024
3.0 TDI 4motion	165/224	06/2016-	6MT	TT01-95-024

VW Amarok - Camión plataforma



TT01-95-024

Cajas de transfer

Modelo	kW/HP	Año	Caja	Referencia
2.0 TDI 4motion	103/140	09/2011-	6MT	TT01-95-024
2.0 TDI 4motion	120/163	09/2011-	6MT	TT01-95-024
2.0 TDI 4motion	132/180	09/2011-	6MT	TT01-95-024

VW Caddy III Mini van (2KB, 2KJ, 2CB, 2CJ)



TT02-95-006



TT02-95-014

Diferencial delantero

Modelo	kW/HP	Año	Caja	Referencia
1.9 TDI 4motion	77/105	05/2008-08/2010	6MT	TT02-95-006
2.0 TDI 16V 4motion	103/140	11/2010-05/2015	6MT	TT02-95-014
2.0 TDI 4motion	81/110	08/2010-05/2015	6MT	TT02-95-006

VW Caddy III Station wagon (2KA, 2KH, 2CA, 2CH)



TT02-95-006



TT02-95-014

Diferencial delantero

Modelo	kW/HP	Año	Caja	Referencia
1.9 TDI 4motion	77/105	11/2008-08/2010	6MT	TT02-95-006
2.0 TDI 16V 4motion	103/140	11/2010-05/2015	6MT	TT02-95-014
2.0 TDI 4motion	62/85	12/2010-05/2015	6MT	TT02-95-006
2.0 TDI 4motion	81/110	08/2010-05/2015	6MT	TT02-95-006

VW Bora (1J2)



TT03-95-016



TT03-95-017

Diferencial trasero

Modelo	kW/HP	Año	Caja	Referencia
1.9 TDI 4motion	110/150	05/2000-05/2005	6MT	TT03-95-017
1.9 TDI 4motion	74/101	09/2000-05/2005	5MT	TT03-95-017
1.9 TDI 4motion	74/101	09/2000-05/2005	6MT	TT03-95-017
1.9 TDI 4motion	85/115	02/1999-06/2001	5MT	TT03-95-017
1.9 TDI 4motion	96/130	11/2000-05/2005	6MT	TT03-95-017
2.3 V5 4motion	110/150	12/1998-10/2000	5MT	TT03-95-016
2.3 V5 4motion	110/150	12/1998-10/2000	6MT	TT03-95-016
2.3 V5 4motion	125/170	10/2000-05/2005	6MT	TT03-95-016
2.3 V5 4motion	125/170	10/2000-05/2005	5MT	TT03-95-016
2.8 V6 4motion	150/204	03/1999-05/2005	6MT	TT03-95-016

VW Bora Variant (1J6)



TT03-95-016



TT03-95-017

Diferencial trasero

Modelo	kW/HP	Año	Caja	Referencia
1.9 TDI 4motion	110/150	05/2000-05/2005	6MT	TT03-95-017
1.9 TDI 4motion	74/101	09/2000-05/2005	5MT	TT03-95-017
1.9 TDI 4motion	74/101	09/2000-05/2005	6MT	TT03-95-017
1.9 TDI 4motion	85/115	02/1999-06/2001	5MT	TT03-95-017
1.9 TDI 4motion	96/130	11/2000-05/2005	6MT	TT03-95-017
2.3 V5 4motion	110/150	12/1998-10/2000	5MT	TT03-95-016
2.3 V5 4motion	110/150	12/1998-10/2000	6MT	TT03-95-016
2.3 V5 4motion	125/170	10/2000-05/2005	6MT	TT03-95-016
2.3 V5 4motion	125/170	10/2000-05/2005	5MT	TT03-95-016
2.8 V6 4motion	150/204	03/1999-05/2005	6MT	TT03-95-016



VW Golf IV (1J1)



TT02-95-004



TT03-95-016



TT03-95-017

Diferencial delantero

Modelo	kW/HP	Año	Caja	Referencia
3.2 R32 4motion	177/241	09/2002-06/2005	6AT	TT02-95-004
3.2 R32 4motion	179/243	09/2002-12/2003	6AT	TT02-95-004

Diferencial trasero

Modelo	kW/HP	Año	Caja	Referencia
1.9 TDI 4motion	110/150	02/2000-06/2005	6MT	TT03-95-017
1.9 TDI 4motion	74/101	09/2000-06/2005	5MT	TT03-95-017
1.9 TDI 4motion	74/101	09/2000-06/2005	6MT	TT03-95-017
1.9 TDI 4motion	85/115	09/1999-06/2001	6MT	TT03-95-017
1.9 TDI 4motion	96/130	11/2000-06/2005	6MT	TT03-95-017
2.3 V5 4motion	110/150	12/1998-10/2000	6MT	TT03-95-016
2.3 V5 4motion	110/150	12/1998-10/2000	5MT	TT03-95-016
2.3 V5 4motion	125/170	10/2000-06/2005	5MT	TT03-95-016
2.3 V5 4motion	125/170	10/2000-06/2005	6MT	TT03-95-016
2.8 V6 4motion	150/204	03/1999-06/2005	6MT	TT03-95-016
3.2 R32 4motion	177/241	09/2002-06/2005	6AT	TT03-95-016
3.2 R32 4motion	179/243	09/2002-12/2003	6AT	TT03-95-016

VW Golf IV Variant (1J5)



TT03-95-016



TT03-95-017

Diferencial trasero

Modelo	kW/HP	Año	Caja	Referencia
1.9 TDI 4motion	110/150	05/2002-06/2005	6MT	TT03-95-017
1.9 TDI 4motion	74/101	09/2000-06/2006	6MT	TT03-95-017
1.9 TDI 4motion	74/101	09/2000-06/2006	5MT	TT03-95-017
1.9 TDI 4motion	85/115	05/1999-06/2001	6MT	TT03-95-017
1.9 TDI 4motion	96/130	11/2000-06/2006	6MT	TT03-95-017
2.3 V5 4motion	110/150	05/1999-06/2006	5MT	TT03-95-016
2.3 V5 4motion	110/150	05/1999-06/2006	6MT	TT03-95-016
2.3 V5 4motion	125/170	10/2000-06/2006	6MT	TT03-95-016
2.3 V5 4motion	125/170	10/2000-06/2006	6MT	TT03-95-016
2.8 V6 4motion	150/204	05/1999-06/2006	6MT	TT03-95-016

VW Golf V (1K1)



TT02-95-013



TT02-95-006



TT02-95-014



TT03-95-005



TT03-95-006

Diferencial delantero

Modelo	kW/HP	Año	Caja	Referencia
1.9 TDI 4motion	77/105	08/2004-11/2008	6MT	TT02-95-006
2.0 FSI 4motion	110/150	08/2004-11/2008	6MT	TT02-95-013
2.0 TDI 16V 4motion	103/140	08/2004-11/2008	6MT	TT02-95-006
2.0 TDI 4motion	103/140	08/2004-11/2008	6MT	TT02-95-006
3.2 R32 4motion	177/241	01/2004-11/2008	6AT	TT02-95-014
3.2 R32 4motion	177/241	01/2004-11/2008	6MT	TT02-95-006
3.2 R32 4motion	184/250	11/2005-11/2008	6AT	TT02-95-014
3.2 R32 4motion	184/250	11/2005-11/2008	6MT	TT02-95-006

Diferencial trasero

Modelo	kW/HP	Año	Caja	Referencia
1.9 TDI 4motion	77/105	08/2004-11/2008	6MT	TT03-95-006
2.0 FSI 4motion	110/150	08/2004-11/2008	6MT	TT03-95-005
2.0 TDI 16V 4motion	103/140	08/2004-11/2008	6MT	TT03-95-006
2.0 TDI 4motion	103/140	08/2004-11/2008	6MT	TT03-95-006
3.2 R32 4motion	177/241	01/2004-11/2008	6AT	TT03-95-005
3.2 R32 4motion	177/241	01/2004-11/2008	6MT	TT03-95-005
3.2 R32 4motion	184/250	11/2005-11/2008	6MT	TT03-95-005
3.2 R32 4motion	184/250	11/2005-11/2008	6AT	TT03-95-005

VW Golf V Variant (1K5)



TT02-95-006



TT03-95-006

Diferencial delantero

Modelo	kW/HP	Año	Caja	Referencia
1.9 TDI 4motion	77/105	01/2008-07/2009	6MT	TT02-95-006

Diferencial trasero

Modelo	kW/HP	Año	Caja	Referencia
1.9 TDI 4motion	77/105	01/2008-07/2009	6MT	TT03-95-006

VW Golf VI (5K1)



TT02-95-006



TT02-95-014



TT03-95-008

Diferencial delantero

Modelo	kW/HP	Año	Caja	Referencia
2.0 4motion	191/260	09/2011-11/2013	6MT	TT02-95-006
2.0 R 4motion	188/256	11/2009-11/2013	6MT	TT02-95-006
2.0 R 4motion	188/256	11/2009-11/2013	6AT	TT02-95-014
2.0 R 4motion	195/265	11/2009-05/2011	6MT	TT02-95-006
2.0 R 4motion	199/270	11/2009-11/2012	6MT	TT02-95-006
2.0 R 4motion	199/270	11/2009-11/2012	6AT	TT02-95-014
2.0 TDI 4motion	103/140	05/2009-11/2012	6MT	TT02-95-006

Diferencial trasero

Modelo	kW/HP	Año	Caja	Referencia
2.0 4motion	191/260	09/2011-11/2013	6MT	TT03-95-008
2.0 R 4motion	188/256	11/2009-11/2013	6MT	TT03-95-008
2.0 R 4motion	188/256	11/2009-11/2013	6AT	TT03-95-008
2.0 R 4motion	195/265	11/2009-05/2011	6MT	TT03-95-008
2.0 R 4motion	199/270	11/2009-11/2012	6MT	TT03-95-008
2.0 R 4motion	199/270	11/2009-11/2012	6AT	TT03-95-008
2.0 TDI 4motion	103/140	05/2009-11/2012	6MT	TT03-95-008

VW Golf VI Variant (AJ5)



TT02-95-006

Diferencial delantero

Modelo	kW/HP	Año	Caja	Referencia
1.6 TDI 4motion	77/105	07/2009-07/2013	6MT	TT02-95-006



TT03-95-008

Diferencial trasero

Modelo	kW/HP	Año	Caja	Referencia
1.6 TDI 4motion	77/105	07/2009-07/2013	6MT	TT03-95-008

VW Passat (362)



TT02-95-006



TT02-95-014



TT03-95-013

Diferencial delantero

Modelo	kW/HP	Año	Caja	Referencia
2.0 TDI 4motion	103/140	08/2010-12/2014	6MT	TT02-95-006
2.0 TDI 4motion	125/170	08/2010-01/2013	6AT	TT02-95-014
2.0 TDI 4motion	125/170	08/2010-01/2013	6MT	TT02-95-006
2.0 TDI 4motion	130/177	01/2013-12/2014	6AT	TT02-95-014
3.6 FSI 4motion	220/300	01/2011-12/2014	6AT	TT02-95-014

Diferencial trasero

Modelo	kW/HP	Año	Caja	Referencia
2.0 TDI 4motion	103/140	08/2010-12/2014	6MT	TT03-95-013
2.0 TDI 4motion	125/170	08/2010-01/2013	6MT	TT03-95-013
2.0 TDI 4motion	125/170	08/2010-01/2013	6AT	TT03-95-013
2.0 TDI 4motion	130/177	01/2013-12/2014	6AT	TT03-95-013
3.6 FSI 4motion	220/300	01/2011-12/2014	6AT	TT03-95-013

VW Passat (362)



TT02-95-013



TT02-95-011



TT02-95-006



TT02-95-014

Diferencial delantero

Modelo	kW/HP	Año	Caja	Referencia
2.0 FSI 4motion	110/150	09/2005-07/2010	6MT	TT02-95-013
2.0 TDI 16V 4motion	103/140	03/2005-02/2008	6MT	TT02-95-006
2.0 TDI 16V 4motion	103/140	03/2005-02/2008	6AT	TT02-95-006
2.0 TDI 16V 4motion	103/140	02/2008-08/2010	6AT	TT02-95-013
2.0 TDI 16V 4motion	103/140	02/2008-08/2010	6MT	TT02-95-013
2.0 TDI 4motion	103/140	03/2005-05/2009	6AT	TT02-95-006

Diferencial delantero

Modelo	kW/HP	Año	Caja	Referencia
2.0 TDI 4motion	103/140	03/2005-05/2009	6MT	TT02-95-006
2.0 TDI 4motion	125/170	05/2009-07/2010	6MT	TT02-95-013
2.0 TDI 4motion	125/170	05/2009-07/2010	6AT	TT02-95-013
3.2 FSI 4motion	184/250	11/2005-07/2010	6AT	TT02-95-014
3.6 FSI 4motion	206/280	09/2005-07/2010	6AT	TT02-95-011
3.6 R36 4motion	220/300	04/2007-07/2010	6AT	TT02-95-014

VW Passat (3C2)



TT03-95-005



TT03-95-006



TT03-95-015



TT03-95-013

Diferencial trasero

Modelo	kW/HP	Año	Caja	Referencia
2.0 FSI 4motion	110/150	09/2005-05/2006	6MT	TT03-95-005
2.0 FSI 4motion	110/150	06/2008-07/2010	6MT	TT03-95-013
2.0 TDI 16V 4motion	103/140	03/2005-05/2006	6AT	TT03-95-006
2.0 TDI 16V 4motion	103/140	03/2005-05/2006	6MT	TT03-95-006
2.0 TDI 16V 4motion	103/140	05/2006-05/2008	6MT	TT03-95-015
2.0 TDI 16V 4motion	103/140	05/2006-05/2008	6AT	TT03-95-015
2.0 TDI 16V 4motion	103/140	05/2008-08/2010	6AT	TT03-95-013
2.0 TDI 16V 4motion	103/140	05/2008-08/2010	6MT	TT03-95-013
2.0 TDI 4motion	103/140	03/2005-05/2006	6AT	TT03-95-006
2.0 TDI 4motion	103/140	03/2005-05/2006	6MT	TT03-95-006

Diferencial trasero

Modelo	kW/HP	Año	Caja	Referencia
2.0 TDI 4motion	103/140	05/2006-06/2008	6MT	TT03-95-015
2.0 TDI 4motion	103/140	05/2006-06/2008	6AT	TT03-95-015
2.0 TDI 4motion	103/140	06/2008-05/2009	6MT	TT03-95-013
2.0 TDI 4motion	103/140	06/2008-05/2009	6AT	TT03-95-013
2.0 TDI 4motion	125/170	05/2009-07/2010	6AT	TT03-95-013
2.0 TDI 4motion	125/170	05/2009-07/2010	6MT	TT03-95-013
3.2 FSI 4motion	184/250	11/2005-05/2006	6AT	TT03-95-005
3.2 FSI 4motion	184/250	06/2008-07/2010	6AT	TT03-95-013
3.6 FSI 4motion	206/280	06/2008-07/2010	6AT	TT03-95-013
3.6 R36 4motion	220/300	06/2008-07/2010	6AT	TT03-95-013

VW Passat ALLTRACK (365)



TT02-95-006



TT02-95-014



TT03-95-013

Diferencial delantero

Modelo	kW/HP	Año	Caja	Referencia
2.0 TDI 4motion	103/140	01/2012-12/2014	6MT	TT02-95-006
2.0 TDI 4motion	125/170	01/2012-12/2014	6MT	TT02-95-006
2.0 TDI 4motion	125/170	01/2012-12/2014	6AT	TT02-95-014
2.0 TDI 4motion	130/177	01/2013-12/2014	6AT	TT02-95-014
2.0 TSI 4motion	155/210	01/2012-12/2014	6AT	TT02-95-014

Diferencial trasero

Modelo	kW/HP	Año	Caja	Referencia
2.0 TDI 4motion	103/140	01/2012-12/2014	6MT	TT03-95-013
2.0 TDI 4motion	125/170	01/2012-12/2014	6AT	TT03-95-013
2.0 TDI 4motion	125/170	01/2012-12/2014	6MT	TT03-95-013
2.0 TDI 4motion	130/177	01/2013-12/2014	6AT	TT03-95-013
2.0 TSI 4motion	155/210	01/2012-12/2014	6AT	TT03-95-013

VW Passat Variant (365)



TT02-95-006



TT02-95-014



TT03-95-013

Diferencial delantero

Modelo	kW/HP	Año	Caja	Referencia
2.0 TDI 4motion	103/140	08/2010-12/2014	6MT	TT02-95-006
2.0 TDI 4motion	125/170	08/2010-01/2013	6AT	TT02-95-014
2.0 TDI 4motion	125/170	08/2010-01/2013	6MT	TT02-95-006
2.0 TDI 4motion	130/177	01/2013-12/2014	6AT	TT02-95-014
3.6 FSI 4motion	220/300	01/2011-12/2014	6AT	TT02-95-014

Diferencial trasero

Modelo	kW/HP	Año	Caja	Referencia
2.0 TDI 4motion	103/140	08/2010-12/2014	6MT	TT03-95-013
2.0 TDI 4motion	125/170	08/2010-01/2013	6MT	TT03-95-013
2.0 TDI 4motion	125/170	08/2010-01/2013	6AT	TT03-95-013
2.0 TDI 4motion	130/177	01/2013-12/2014	6AT	TT03-95-013
3.6 FSI 4motion	220/300	01/2011-12/2014	6AT	TT03-95-013

VW Passat Variant (3C5)

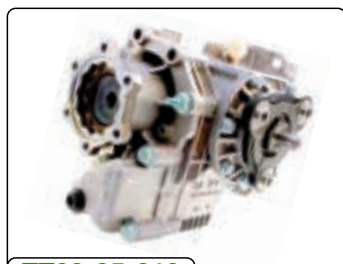

TT02-95-013



TT02-95-011

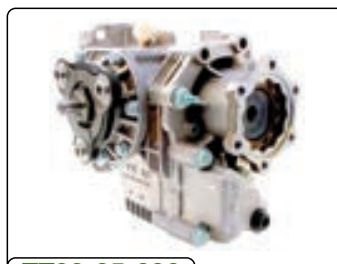

TT02-95-006

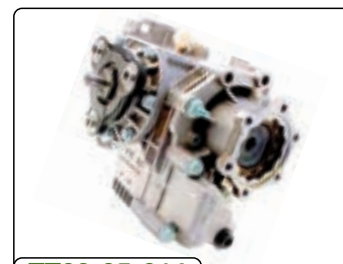

TT02-95-014

Diferencial delantero

Modelo	kW/HP	Año	Caja	Referencia
2.0 FSI 4motion	110/150	09/2005-11/2010	6MT	TT02-95-013
2.0 TDI 16V 4motion	103/140	08/2005-02/2008	6MT	TT02-95-006
2.0 TDI 16V 4motion	103/140	08/2005-02/2008	6AT	TT02-95-006
2.0 TDI 16V 4motion	103/140	02/2008-11/2010	6AT	TT02-95-013
2.0 TDI 16V 4motion	103/140	02/2008-11/2010	6MT	TT02-95-013
2.0 TDI 4motion	103/140	08/2005-05/2009	6MT	TT02-95-006
2.0 TDI 4motion	103/140	08/2005-05/2009	6AT	TT02-95-006
2.0 TDI 4motion	125/170	05/2009-11/2010	6AT	TT02-95-013
2.0 TDI 4motion	125/170	05/2009-11/2010	6MT	TT02-95-013
3.2 FSI 4motion	184/250	11/2005-11/2010	6AT	TT02-95-014
3.6 FSI 4motion	206/280	09/2005-11/2010	6AT	TT02-95-011
3.6 R36 4motion	220/300	04/2007-11/2010	6AT	TT02-95-014

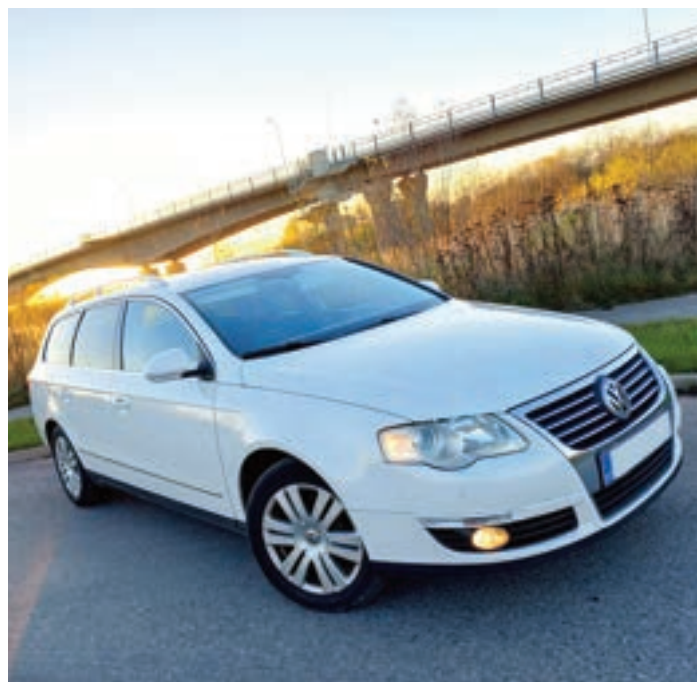

VW Passat Variant (3C5)



TT03-95-005



TT03-95-006



TT03-95-015



TT03-95-013

Diferencial trasero

Modelo	kW/HP	Año	Caja	Referencia
2.0 FSI 4motion	110/150	09/2005-05/2006	6MT	TT03-95-005
2.0 FSI 4motion	110/150	06/2008-11/2010	6MT	TT03-95-013
2.0 TDI 16V 4motion	103/140	08/2005-05/2006	6AT	TT03-95-006
2.0 TDI 16V 4motion	103/140	08/2005-05/2006	6MT	TT03-95-006
2.0 TDI 16V 4motion	103/140	05/2006-11/2010	6AT	TT03-95-015
2.0 TDI 16V 4motion	103/140	05/2006-11/2010	6MT	TT03-95-015
2.0 TDI 16V 4motion	103/140	06/2008-11/2010	6MT	TT03-95-013
2.0 TDI 16V 4motion	103/140	06/2008-11/2010	6AT	TT03-95-013
2.0 TDI 4motion	103/140	08/2005-05/2006	6MT	TT03-95-006
2.0 TDI 4motion	103/140	08/2005-05/2006	6AT	TT03-95-006
2.0 TDI 4motion	103/140	05/2006-06/2008	6AT	TT03-95-015

Diferencial trasero

Modelo	kW/HP	Año	Caja	Referencia
2.0 TDI 4motion	103/140	05/2006-06/2008	6MT	TT03-95-015
2.0 TDI 4motion	103/140	06/2008-05/2009	6AT	TT03-95-013
2.0 TDI 4motion	103/140	06/2008-05/2009	6MT	TT03-95-013
2.0 TDI 4motion	125/170	05/2009-11/2010	6MT	TT03-95-013
2.0 TDI 4motion	125/170	05/2009-11/2010	6AT	TT03-95-013
3.2 FSI 4motion	184/250	11/2005-05/2006	6AT	TT03-95-005
3.2 FSI 4motion	184/250	06/2008-11/2010	6AT	TT03-95-013
3.6 FSI 4motion	206/280	09/2005-05/2006	6AT	TT03-95-005
3.6 FSI 4motion	206/280	06/2008-11/2010	6AT	TT03-95-013
3.6 R36 4motion	220/300	06/2008-11/2010	6AT	TT03-95-013

Phaeton (3D1, 3D2, 3D3, 3D4, 3D6, 3D7, 3D8, 3D9)

Imagen usada como referencia



EST-1071042210800



Cajas de cambio automáticas 6 HP 19 A

Modelo	kW/HP	Año	Caja	Referencia
3.0 V6 TDI 4motion	165/224	2004-2007	6AT	EST-1071042210800
3.0 V6 TDI 4motion	165/224	2004-2007	6AT	EST-1071042310800
3.0 V6 TDI 4motion	176/240	2008-2016	6AT	EST-1071042436800
3.0 V6 TDI 4motion	176/240	2008-2016	6AT	EST-1071042460800
3.6 V6 4motion	206/280	2008-2016	6AT	EST-1071042447000
4.2 V8 4motion	246/335	2003-2016	6AT	EST-1071042462000

Cajas de cambio automáticas 6 HP 32 A

Modelo	kW/HP	Año	Caja	Referencia
5.0 V10 TDI 4motion	230/313	2002-2006	6AT	EST-1070022016000

VW Sharan (7M8, 7M9, 7M6)



TT03-95-022

Diferencial trasero

Modelo	kW/HP	Año	Caja	Referencia
1.9 TDI 4motion	85/115	04/2000-03/2010	6MT	TT03-95-022
2.8 V6 24V 4motion	150/204	04/2000-03/2010	6MT	TT03-95-022

VW Sharan (7N1, 7N2)



TT02-95-010



TT03-95-012



TT03-95-014

Diferencial delantero

Modelo	kW/HP	Año	Caja	Referencia
2.0 TDI 4motion	103/140	05/2011-	6MT	TT02-95-010
2.0 TDI 4motion	110/150	05/2015-	6MT	TT02-95-010
2.0 TDI 4motion	135/184	05/2016-	6MT	TT02-95-010

Diferencial trasero

Modelo	kW/HP	Año	Caja	Referencia
2.0 TDI 4motion	103/140	05/2011-11/2013	6MT	TT03-95-012
2.0 TDI 4motion	103/140	11/2013-	6MT	TT03-95-014
2.0 TDI 4motion	110/150	05/2015-	6MT	TT03-95-014
2.0 TDI 4motion	135/184	05/2016-	6MT	TT03-95-014

VW Tiguan (5N_)



TT02-95-010



TT02-95-011



TT02-95-012

Diferencial delantero

Modelo	kW/HP	Año	Caja	Referencia
1.4 TSI 4motion	110/150	09/2007-	6MT	TT02-95-010
1.4 TSI 4motion	118/160	05/2011-	6MT	TT02-95-010
2.0 TDI 4motion"	100/136	11/2007-	6MT	TT02-95-010
2.0 TDI 4motion	100/136	11/2007-	7AT	TT02-95-012
2.0 TDI 4motion	103/140	09/2007-	6MT	TT02-95-010
2.0 TDI 4motion	103/140	09/2007-	7AT	TT02-95-012
2.0 TDI 4motion	110/150	05/2015-	7AT	TT02-95-012
2.0 TDI 4motion	110/150	05/2015-	6MT	TT02-95-010
2.0 TDI 4motion	120/163	02/2008-08/2009	6MT	TT02-95-010
2.0 TDI 4motion	125/170	09/2007-	6AT	TT02-95-011
2.0 TDI 4motion	125/170	09/2007-	6MT	TT02-95-010
2.0 TDI 4motion	130/177	11/2012-	7AT	TT02-95-012
2.0 TDI 4motion	130/177	11/2012-	6MT	TT02-95-010

Diferencial delantero

Modelo	kW/HP	Año	Caja	Referencia
2.0 TDI 4motion	135/184	05/2015-	7AT	TT02-95-012
2.0 TDI 4motion	135/184	05/2015-	6MT	TT02-95-010
2.0 TFS 4motion	125/170	09/2007-	6MT	TT02-95-010
2.0 TFSI 4motion	125/170	09/2007-	6AT	TT02-95-011
2.0 TFSI 4motion	147/200	09/2007-11/2013	6AT	TT02-95-011
2.0 TFSI 4motion	147/200	09/2007-	6MT	TT02-95-010
2.0 TFSI 4motion	147/200	09/2007-	7AT	TT02-95-012
2.0 TSI 4motion	132/180	05/2011-	7AT	TT02-95-012
2.0 TSI 4motion	132/180	05/2011-	6AT	TT02-95-011
2.0 TSI 4motion	132/180	05/2011-	6MT	TT02-95-010
2.0 TSI 4motion	155/211	05/2011-	7AT	TT02-95-012
2.0 TSI 4motion	155/211	05/2011-	6MT	TT02-95-010

VW Tiguan (5N_)



TT03-95-012



TT03-95-014

Diferencial trasero				
Modelo	kW/HP	Año	Caja	Referencia
1.4 TSI 4motion	110/150	09/2007-	6MT	TT03-95-012
1.4 TSI 4motion	118/160	05/2011-11/2013	6MT	TT03-95-012
1.4 TSI 4motion	118/160	11/2013-	6MT	TT03-95-014
2.0 TDI 4motion"	100/136	11/2007-11/2013	7AT	TT03-95-012
2.0 TDI 4motion"	100/136	11/2007-11/2013	6MT	TT03-95-012
2.0 TDI 4motion"	100/136	11/2013-	7AT	TT03-95-014
2.0 TDI 4motion"	100/136	11/2013-	6MT	TT03-95-014
2.0 TDI 4motion"	103/140	09/2007-11/2013	6MT	TT03-95-012
2.0 TDI 4motion"	103/140	09/2007-11/2013	7AT	TT03-95-012
2.0 TDI 4motion"	103/140	11/2013-	6MT	TT03-95-014
2.0 TDI 4motion"	103/140	11/2013-	7AT	TT03-95-014
2.0 TDI 4motion"	103/140	11/2013-	7AT	TT03-95-014
2.0 TDI 4motion"	110/150	05/2015-	6MT	TT03-95-014
2.0 TDI 4motion"	110/150	05/2015-	7AT	TT03-95-014
2.0 TDI 4motion"	120/163	02/2008-08/2009	6MT	TT03-95-012
2.0 TDI 4motion"	125/170	09/2007-11/2013	6AT	TT03-95-012
2.0 TDI 4motion"	125/170	09/2007-11/2013	6MT	TT03-95-012
2.0 TDI 4motion"	125/170	11/2013-	6AT	TT03-95-014
2.0 TDI 4motion"	125/170	11/2013-	6MT	TT03-95-014
2.0 TDI 4motion"	130/177	11/2012-11/2013	7AT	TT03-95-012
2.0 TDI 4motion"	130/177	11/2012-11/2013	6MT	TT03-95-012
2.0 TDI 4motion"	130/177	11/2013-	7AT	TT03-95-014

Diferencial trasero				
Modelo	kW/HP	Año	Caja	Referencia
2.0 TDI 4motion"	130/177	11/2013-	6MT	TT03-95-014
2.0 TDI 4motion"	135/184	05/2015-	6MT	TT03-95-014
2.0 TDI 4motion"	135/184	05/2015-	7AT	TT03-95-014
2.0 TFSI 4motion"	125/170	09/2007-11/2013	6MT	TT03-95-012
2.0 TFSI 4motion"	125/170	11/2013-	6MT	TT03-95-014
2.0 TFSI 4motion"	147/200	09/2007-11/2013	7AT	TT03-95-012
2.0 TFSI 4motion"	147/200	09/2007-11/2013	6MT	TT03-95-012
2.0 TFSI 4motion"	147/200	09/2007-11/2013	6AT	TT03-95-012
2.0 TFSI 4motion"	147/200	11/2013-	6AT	TT03-95-014
2.0 TFSI 4motion"	147/200	11/2013-	7AT	TT03-95-014
2.0 TFSI 4motion"	147/200	11/2013-	6MT	TT03-95-014
2.0 TSI 4motion	132/180	05/2011-11/2013	6AT	TT03-95-012
2.0 TSI 4motion	132/180	05/2011-11/2013	7AT	TT03-95-012
2.0 TSI 4motion	132/180	05/2011-11/2013	6MT	TT03-95-012
2.0 TSI 4motion	132/180	11/2013-	7AT	TT03-95-014
2.0 TSI 4motion	132/180	11/2013-	6AT	TT03-95-014
2.0 TSI 4motion	132/180	11/2013-	6MT	TT03-95-014
2.0 TSI 4motion	155/211	05/2011-11/2013	6MT	TT03-95-012
2.0 TSI 4motion	155/211	05/2011-11/2013	7AT	TT03-95-012
2.0 TSI 4motion	155/211	11/2013-	6MT	TT03-95-014
2.0 TSI 4motion	155/211	11/2013-	7AT	TT03-95-014



VW Tiguan (AD1)



TT02-95-010



TT02-95-011



TT02-95-012



TT03-95-014

Diferencial delantero

Modelo	kW/HP	Año	Caja	Referencia
1.4 TSI 4motion	110/150	05/2016-	6DCTT	TT02-95-011
1.4 TSI 4motion	110/150	05/2016-	6MT	TT02-95-010
2.0 TDI 4motion	110/150	01/2016-	6MT	TT02-95-010
2.0 TDI 4motion	110/150	01/2016-	7DCTT	TT02-95-012
2.0 TDI 4motion	130/177	08/2016-	7DCTT	TT02-95-012
2.0 TDI 4motion	140/190	04/2016-	7DCTT	TT02-95-012
2.0 TDI 4motion	176/240	05/2016-	7DCTT	TT02-95-012
2.0 TSI 4motion	132/180	01/2016-	6MT	TT02-95-012
2.0 TSI 4motion	132/180	01/2016-	7DCTT	TT02-95-012
2.0 TSI 4motion	162/220	06/2016-	7DCTT	TT02-95-012
2.0 TSI 4motion	162/220	06/2016-	6MT	TT02-95-012

Diferencial trasero

Modelo	kW/HP	Año	Caja	Referencia
1.4 TSI 4motion	110/150	05/2016-	6MT	TT03-95-014
1.4 TSI 4motion	110/150	05/2016-	6DCTT	TT03-95-014
2.0 TDI 4motion	110/150	01/2016-	7DCTT	TT03-95-014
2.0 TDI 4motion	110/150	01/2016-	6MT	TT03-95-014
2.0 TDI 4motion	130/177	08/2016-	7DCTT	TT03-95-014
2.0 TDI 4motion	140/190	04/2016-	7DCTT	TT03-95-014
2.0 TSI 4motion	132/180	01/2016-	7DCTT	TT03-95-014
2.0 TSI 4motion	132/180	01/2016-	6MT	TT03-95-014
2.0 TSI 4motion	162/220	06/2016-	7DCTT	TT03-95-014
2.0 TSI 4motion	162/220	06/2016-	6MT	TT03-95-014

VW Touareg (7LA, 7L6, 7L7)



TT01-95-010



TT01-95-014



TT01-95-011



TT01-95-012

Cajas de transfer

Modelo	kW/HP	Año	Caja	Referencia
2.5 R5 TDI	120/163	08/2003-05/2010	6MT	TT01-95-011
2.5 R5 TDI	120/163	08/2003-05/2010	6AT	TT01-95-011
2.5 R5 TDI	128/174	01/2003-05/2010	6MT	TT01-95-011
2.5 R5 TDI	128/174	01/2003-05/2010	6AT	TT01-95-011
3.0 TDI	155/211	04/2006-05/2010	6AT	TT01-95-014
3.0 V6 TDI 4motion	209/284	09/2008-05/2010	6AT	TT01-95-014
3.0 V6 TDI	209/284	09/2008-05/2010	6AT	TT01-95-014
3.0 V6 TDI	165/225	11/2004-05/2010	6AT	TT01-95-014
3.0 V6 TDI	176/240	11/2007-05/2010	6AT	TT01-95-014
3.2 V6	162/220	10/2002-11/2006	6AT	TT01-95-012
3.2 V6	162/220	10/2002-11/2006	6MT	TT01-95-011

Cajas de transfer

Modelo	kW/HP	Año	Caja	Referencia
3.2 V6	177/241	11/2004-11/2006	6AT	TT01-95-014
3.6 V6 FSI	206/280	10/2005-05/2010	6AT	TT01-95-012
3.6 V6 FSI	206/280	10/2005-05/2010	6MT	TT01-95-011
4.2 FSI	231/314	09/2007-12/2009	6AT	TT01-95-014
4.2 V8 FSI	257/350	06/2006-05/2010	6AT	TT01-95-014
4.2 V8	228/310	12/2002-11/2006	6AT	TT01-95-011
5.0 R50 TDI	257/350	08/2007-05/2010	6AT	TT01-95-014
5.0 TDI V10	230/313	11/2002-01/2004	6AT	TT01-95-014
5.0 V10 TDI	230/313	10/2002-05/2010	6AT	TT01-95-014
6.0 W12	331/450	08/2004-05/2010	6AT	TT01-95-010

VW Touareg (7P5)



TT01-95-021



TT01-95-016



TT01-95-019



TT01-95-023



TT01-95-015

Cajas de transfer

Modelo	kW/HP	Año	Caja	Referencia
3.0 V6 TDI	150/204	09/2010-	8AT	TT01-95-016
3.0 V6 TDI	165/224	06/2010-	8AT	TT01-95-016
3.0 V6 TDI	176/239	02/2010-04/2011	8AT	TT01-95-016
3.0 V6 TDI	180/245	05/2011-	8AT	TT01-95-016

Cajas de transfer

Modelo	kW/HP	Año	Caja	Referencia
3.0 V6 TSI China	245/333	08/2010-	8DCT	TT01-95-023
3.0 V6 TSI Hybrid	245/333	02/2010-	8AT	TT01-95-015
3.6 V6 FSI	206/280	05/2010-04/2013	8AT	TT01-95-019
4.2 V8 TDI	250/340	01/2013-	8AT	TT01-95-021

VW Touareg (7P5, 7P6)



TT01-95-002



TT01-95-003



TT01-95-021



TT01-95-016



TT01-95-019



TT01-95-023



TT01-95-020



TT01-95-022

Cajas de transfer

Modelo	kW/HP	Año	Caja	Referencia
3.0 V6 TDI	150/204	01/2010-	8AT	TT01-95-016
3.0 V6 TDI	150/204	01/2010-	8AT	TT01-95-002
3.0 V6 TDI	165/225	06/2010-	8AT	TT01-95-002
3.0 V6 TDI	165/225	06/2010-	8AT	TT01-95-016
3.0 V6 TDI	176/240	01/2010-	8AT	TT01-95-002
3.0 V6 TDI	176/240	01/2010-	8AT	TT01-95-016
3.0 V6 TDI	180/245	05/2011-	8AT	TT01-95-016
3.0 V6 TDI	180/245	05/2011-	8AT	TT01-95-002
3.0 V6 TDI	193/262	09/2014-	8AT	TT01-95-016
3.0 V6 TDI	209/284	09/2010-	8AT	TT01-95-016
3.0 V6 TDI	209/284	09/2010-	8AT	TT01-95-002
3.0 V6 TSI Hybrid	245/333	04/2010-	8AT	TT01-95-015
3.0 V6 TSI Hybrid	283/385	09/2010-	8AT	TT01-95-015

Cajas de transfer

Modelo	kW/HP	Año	Caja	Referencia
3.0 V6 TSI	213/290	08/2010-	8AT	TT01-95-015
3.0 V6 TSI	235/320	01/2015-	8AT	TT01-95-002
3.0 V6 TSI	235/320	01/2015-	8AT	TT01-95-023
3.6 V6 FSI	183/249	08/2010-	8AT	TT01-95-019
3.6 V6 FSI	183/249	08/2010-	8AT	TT01-95-002
3.6 V6 FSI	206/280	04/2010-	8AT	TT01-95-003
3.6 V6 FSI	206/280	04/2010-	8AT	TT01-95-019
3.6 V6 FSI	206/280	04/2010-	8AT	TT01-95-002
4.2 V8 FSI	265/360	01/2011-	8AT	TT01-95-022
4.2 V8 TDI	250/340	01/2010-	8AT	TT01-95-020
4.2 V8 TDI	250/340	01/2010-	8AT	TT01-95-021

VW Transporter Multivan V (7HM, 7HN, 7HF, 7EF, 7EM, 7EN)



TT02-95-008



TT03-95-001



TT03-95-002



TT03-95-018



TT03-95-019

Diferencial delantero

Modelo	kW/HP	Año	Caja	Referencia
2.0 BiTDI 4motion	132/180	09/2009-08/2015	7AT	TT02-95-008
2.0 TSI 4motion	150/204	07/2011-08/2015	7AT	TT02-95-008

Diferencial trasero

Modelo	kW/HP	Año	Caja	Referencia
2.0 BiTDI 4motion	132/180	09/2009-08/2015	7AT	TT03-95-001
2.0 BiTDI 4motion	132/180	09/2009-08/2015	7AT	TT03-95-002
2.0 TDI 4motion	100/136	05/2010-08/2015	6MT	TT03-95-002
2.0 TDI 4motion	100/136	05/2010-08/2015	6MT	TT03-95-001
2.0 TDI 4motion	103/140	09/2009-08/2015	6MT	TT03-95-001
2.0 TDI 4motion	103/140	09/2009-08/2015	6MT	TT03-95-002
2.0 TSI 4motion	150/204	07/2011-08/2015	7AT	TT03-95-001
2.0 TSI 4motion	150/204	07/2011-08/2015	7AT	TT03-95-002
2.5 TDI 4motion	128/174	07/2004-11/2009	6MT	TT03-95-018
2.5 TDI 4motion	128/174	07/2004-11/2009	6MT	TT03-95-019
2.5 TDI 4motion	96/130	07/2004-11/2009	6MT	TT03-95-018
2.5 TDI 4motion	96/130	07/2004-11/2009	6MT	TT03-95-019
3.2 V6 4motion	173/235	07/2004-11/2009	6MT	TT03-95-018
3.2 V6 4motion	173/235	07/2004-11/2009	6MT	TT03-95-019

VW Transporter MULTIVAN VI (SGF, SGM, SGN)



TT02-95-008



TT02-95-009

Diferencial delantero

Modelo	kW/HP	Año	Caja	Referencia
2.0 TDI 4motion	103/140	06/2015-	6MT	TT02-95-009
2.0 TDI 4motion	110/150	08/2015-	7DCT	TT02-95-008
2.0 TDI 4motion	110/150	08/2015-	6MT	TT02-95-009
2.0 TDI 4motion	132/180	06/2015-	7DCT	TT02-95-008
2.0 TDI 4motion	150/204	06/2015-	7DCT	TT02-95-008
2.0 TSI 4motion	150/204	06/2015-	7DCT	TT02-95-008



VW Transporter IV Camión de plataforma (70XD)



TT02-95-016

Diferencial delantero

Modelo	kW/HP	Año	Caja	Referencia
2.4 D Syncro	57/78	10/1992-09/1998	5MT	TT02-95-016
2.5 Syncro	81/110	10/1992-04/2003	5MT	TT02-95-016
2.5 Syncro	85/115	08/1996-04/2003	5MT	TT02-95-016



TT03-95-023

Diferencial trasero

Modelo	kW/HP	Año	Caja	Referencia
2.4 D Syncro	57/78	10/1992-09/1998	5MT	TT03-95-023
2.5 Syncro	81/110	10/1992-04/2003	5MT	TT03-95-023
2.5 Syncro	85/115	08/1996-04/2003	5MT	TT03-95-023
2.5 TDI Syncro	75/102	05/1998-04/2003	5MT	TT03-95-023

VW Transporter IV Furgón (70XA)



TT02-95-016

Diferencial delantero

Modelo	kW/HP	Año	Caja	Referencia
2.4 D Syncro	57/78	10/1992-09/1998	5MT	TT02-95-016
2.5 Syncro	81/110	10/1992-04/2003	5MT	TT02-95-016
2.5 Syncro	85/115	08/1996-04/2003	5MT	TT02-95-016



TT03-95-023

Diferencial trasero

Modelo	kW/HP	Año	Caja	Referencia
2.4 D Syncro	57/78	10/1992-09/1998	5MT	TT03-95-023
2.5 Syncro	81/110	10/1992-04/2003	5MT	TT03-95-023
2.5 Syncro	85/115	08/1996-04/2003	5MT	TT03-95-023
2.5 TDI Syncro	75/102	1995/09-04/2003	5MT	TT03-95-023

VW Transporter IV Minibus (70XB, 70XC, 7DB, 7DW, 7DK)



TT02-95-016

Diferencial delantero

Modelo	kW/HP	Año	Caja	Referencia
2.4 D Syncro	57/78	10/1992-09/1998	5MT	TT02-95-016
2.5 Syncro	81/110	11/1992-04/2003	5MT	TT02-95-016
2.5 Syncro	85/115	07/1996-04/2003	5MT	TT02-95-016
2.8 VR6 Syncro	103/140	01/1996-04/1996	5MT	TT02-95-016



TT03-95-023

Diferencial trasero

Modelo	kW/HP	Año	Caja	Referencia
2.4 D Syncro	57/78	10/1992-09/1998	5MT	TT03-95-023
2.5 Syncro	81/110	11/1992-04/2003	5MT	TT03-95-023
2.5 Syncro	85/115	07/1996-04/2003	5MT	TT03-95-023

VW Transporter V Camión de plataforma (7JD, 7JE, 7JL, 7JY, 7JZ)



TT02-95-009

Diferencial delantero

Modelo	kW/HP	Año	Caja	Referencia
2.0 BiTDI 4motion	132/180	09/2009-08/2015	6MT	TT02-95-009
2.0 TDI 4motion	100/136	05/2010-08/2015	6MT	TT02-95-009
2.0 TDI 4motion	103/140	09/2009-08/2015	6MT	TT02-95-009

VW Transporter V Camión de plataforma (7JD, 7JE, 7JL, 7JY, 7JZ)



TT03-95-001



TT03-95-002



TT03-95-018



TT03-95-019

Diferencial trasero

Modelo	kW/HP	Año	Caja	Referencia
2.0 BiTDI 4motion	132/180	09/2009-08/2015	6MT	TT03-95-001
2.0 BiTDI 4motion	132/180	09/2009-08/2015	6MT	TT03-95-002
2.0 TDI 4motion	100/136	05/2010-08/2015	6MT	TT03-95-002
2.0 TDI 4motion	100/136	05/2010-08/2015	6MT	TT03-95-001
2.0 TDI 4motion	103/140	09/2009-08/2015	6MT	TT03-95-002
2.0 TDI 4motion	103/140	09/2009-08/2015	6MT	TT03-95-001

Diferencial trasero

Modelo	kW/HP	Año	Caja	Referencia
2.5 TDI 4motion	128/174	04/2004-11/2009	6MT	TT03-95-019
2.5 TDI 4motion	128/174	04/2004-11/2009	6MT	TT03-95-018
2.5 TDI 4motion	96/130	07/2004-11/2009	6MT	TT03-95-019
2.5 TDI 4motion	96/130	07/2004-11/2009	6MT	TT03-95-018
3.2 4motion	170/231	11/2003-11/2009	6MT	TT03-95-018
3.2 4motion	170/231	11/2003-11/2009	6MT	TT03-95-019



Kits de mantenimiento cajas ZF



EST-1058298046

Tipo transmisión: 5HP24
 Híbrida: –
 Versión: Kit con aceite
 Vehículos:
 Alpina, BMW, Jaguar, Land Rover



EST-1058298047

Tipo transmisión: 5HP24A
 Híbrida: –
 Versión: Kit con aceite
 Vehículos:
 Audi



EST-1058298048

Tipo transmisión: 5HP24
 Híbrida: –
 Versión: Kit sin aceite
 Vehículos:
 Alpina, BMW, Jaguar, Land Rover



EST-1058298049

Tipo transmisión: 5HP24A
 Híbrida: –
 Versión: Kit sin aceite
 Vehículos:
 Audi



EST-1060298069

Tipo transmisión: 5HP19FL / FLA
 Híbrida: –
 Versión: Kit con aceite
 Vehículos:
 Audi, Porsche, Škoda, VW



EST-1060298070

Tipo transmisión: 5HP19
 Híbrida: –
 Versión: Kit con aceite
 Vehículos:
 Alpina, BMW



EST-1060298072

Tipo transmisión: 5HP19
 Híbrida: –
 Versión: Kit sin aceite
 Vehículos:
 Alpina, BMW



EST-1060298073

Tipo transmisión: 5HP19FL / FLA
 Híbrida: –
 Versión: Kit sin aceite
 Vehículos:
 Audi, Porsche, Škoda, VW



EST-1068298054

Tipo transmisión: 6HP26A61
 Híbrida: –
 Versión: Kit con aceite
 Vehículos:
 Audi, Bentley



EST-1068298061

Tipo transmisión:
 6HP26X/6HP32 (HSL015+016)
 Híbrida: –
 Versión: Kit con aceite
 Vehículos:
 BMW, Lincoln



EST-1068298062

Tipo transmisión:
 6HP26/26x/28/28x/32
 Híbrida: –
 Versión: Kit con aceite
 Vehículos:
 Alpina, Aston Martin, Bentley,
 BMW, Ford, Hyundai, Jaguar,
 Land Rover, Lincoln,
 Rolls-Royce, Wiesmann



EST-1068298083

Tipo transmisión:
 6HP26/26x/28/28x/32
 Híbrida: –
 Versión: Kit sin aceite
 Vehículos:
 Alpina, Aston Martin, Bentley,
 BMW, Ford, Hyundai, Jaguar,
 Land Rover, Lincoln,
 Rolls-Royce, Wiesmann

Kits de mantenimiento cajas ZF



EST-1068298084

Tipo transmisión:
6HP26X/6HP32 (HSL015+016)
Híbrida: –
Versión: Kit sin aceite
Vehículos:
BMW, Lincoln



EST-1068298085

Tipo transmisión: 6HP26A61
Híbrida: –
Versión: Kit sin aceite
Vehículos:
Audi, Bentley



EST-1071298027

Tipo transmisión: 6HP19A
Híbrida: –
Versión: Kit con aceite
Vehículos:
Audi, Volkswagen



EST-1071298033

Tipo transmisión:
6HP19 /x/21/21x
Híbrida: –
Versión: Kit con aceite
Vehículos:
BMW



EST-1071298038

Tipo transmisión:
6HP19 /x/21/21x
Híbrida: –
Versión: Kit sin aceite
Vehículos:
BMW



EST-1071298039

Tipo transmisión: 6HP19A
Híbrida: –
Versión: Kit sin aceite
Vehículos:
Audi, Volkswagen



EST-1084298013

Tipo transmisión: 6HP28AF
Híbrida: –
Versión: Kit con aceite
Vehículos:
Audi



EST-1084298014

Tipo transmisión: 6HP28AF
Híbrida: –
Versión: Kit sin aceite
Vehículos:
Audi



EST-1087298360

Tipo transmisión: 8HP70/X/HIS
Híbrida: –
Versión: Kit con aceite
Vehículos:
Chrysler



EST-1087298361

Tipo transmisión: 8HP70/X/HIS
Híbrida: –
Versión: Kit sin aceite
Vehículos:
Chrysler



EST-1087298362

Tipo transmisión: 8P70XH
Híbrida: Si
Versión: Kit sin aceite
Vehículos:
Land Rover



EST-1087298363

Tipo transmisión: 8P70XH
Híbrida: Si
Versión: Kit con aceite
Vehículos:
Land Rover

Kits de mantenimiento cajas ZF



EST-1087298364

Tipo transmisión:
8HP45/X;8HP70T;8HP70/X;8HP4
5/50/70/75+X+XHIS;
8HP70H;8HP70/X

Híbrida: –

Versión: Kit sin aceite

Vehículos:

Aston Martin, BMW, Chrysler,
Jaguar, Land Rover, Maserati



EST-1087298365

Tipo transmisión:
8HP45/X;8HP70T;8HP70/X;8HP4
5/50/70/75+X+XHIS;
8HP70H;8HP70/X

Híbrida: –

Versión: Kit con aceite

Vehículos:

Aston Martin, BMW, Chrysler,
Jaguar, Land Rover, Maserati



EST-1087298366

Tipo transmisión: 8P70H

Híbrida: Si

Versión: Kit sin aceite

Vehículos:

BMW



EST-1087298367

Tipo transmisión: 8P70H

Híbrida: Si

Versión: Kit con aceite

Vehículos:

BMW



EST-1087298368

Tipo transmisión:
8HP55A/FL/HIS

Híbrida: –

Versión: Kit sin aceite

Vehículos:

Audi



EST-1087298369

Tipo transmisión:
8HP55A/FL/HIS

Híbrida: –

Versión: Kit con aceite

Vehículos:

Audi



EST-1090298126

Tipo transmisión:
8HP45X/8HP45XHIS5HP24

Híbrida: –

Versión: Kit sin aceite

Vehículos:

VW



EST-1090298127

Tipo transmisión:
8HP45X/8HP45XHIS5HP24

Híbrida: –

Versión: Kit con aceite

Vehículos:

VW



EST-1091298066

Tipo transmisión: 8HP90A/HIS

Híbrida: –

Versión: Kit sin aceite

Vehículos:

Audi, Bentley



EST-1091298067

Tipo transmisión: 8HP90A/HIS

Híbrida: –

Versión: Kit con aceite

Vehículos:

Audi, Bentley



EST-1102298018

Tipo transmisión:
8HP75 PH / XPH

Híbrida: Si

Versión: Kit sin aceite

Vehículos:

BMW



EST-1102298019

Tipo transmisión:
8HP75 PH / XPH

Híbrida: Si

Versión: Kit con aceite

Vehículos:

BMW

Kits de mantenimiento cajas ZF



EST-1102298020

Tipo transmisión: 8HP75 X HIS
Híbrida: –
Versión: Kit sin aceite
Vehículos:
 BMW



EST-1102298021

Tipo transmisión: 8HP75 X HIS
Híbrida: –
Versión: Kit con aceite
Vehículos:
 BMW



EST-1103298006

Tipo transmisión: 8HP65 A
Híbrida: –
Versión: Kit sin aceite
Vehículos:
 Audi



EST-1103298007

Tipo transmisión: 8HP65 A
Híbrida: –
Versión: Kit con aceite
Vehículos:
 Audi



EST-1103298112

Tipo transmisión:
 8HP65A/AX/APH/AXPH/
 8HP66APH
Híbrida: –
Versión: Kit sin aceite
Vehículos:
 Audi, Porsche, VW



EST-1103298113

Tipo transmisión:
 8HP65A/AX/APH/AXPH/
 8HP66APH
Híbrida: –
Versión: Kit con aceite
Vehículos:
 Audi, Porsche, VW



EST-1104298050

Tipo transmisión: 8HP95A
Híbrida: –
Versión: Kit sin aceite
Vehículos:
 Audi, Bentley, Lamborguini, VW



EST-1104298051

Tipo transmisión: 8HP95A
Híbrida: –
Versión: Kit con aceite
Vehículos:
 Audi, Bentley, Lamborguini, VW



EST-1104298054

Tipo transmisión:
 8HP95A/8HP95AXPH
Híbrida: –
Versión: Kit sin aceite
Vehículos:
 Audi, Porsche



EST-1104298055

Tipo transmisión:
 8HP95A/8HP95AXPH
Híbrida: –
Versión: Kit con aceite
Vehículos:
 Audi, Porsche



EST-1109298030

Tipo transmisión: 8HP76+X
Híbrida: –
Versión: Kit sin aceite
Vehículos:
 BMW



EST-1109298031

Tipo transmisión: 8HP76+X
Híbrida: –
Versión: Kit con aceite
Vehículos:
 BMW

Kits de mantenimiento cajas ZF



EST-1111298031

Tipo transmisión: 8HP51+X
Híbrida: –
Versión: Kit sin aceite
Vehículos:
 BMW



EST-1111298032

Tipo transmisión: 8HP51+X
Híbrida: –
Versión: Kit con aceite
Vehículos:
 BMW



EST-5961303116

Tipo transmisión: 5 G-Tronic
Híbrida: –
Versión: Kit sin aceite
Vehículos:
 Mercedes



EST-5961303275

Tipo transmisión: DSG (DQ250)
Híbrida: –
 Kit mantenimiento caja de cambios automática
Vehículos:
 Audi, Seat, Skoda, VW



EST-5961303474

Tipo transmisión: 7 G-Tronic
Híbrida: –
Versión: Kit sin aceite
Vehículos:
 Mercedes



EST-5961304069

Tipo transmisión: DCT450
Híbrida: –
 Kit mantenimiento caja de cambios automática
Vehículos:
 Mitsubishi, Volvo



EST-5961306996

Tipo transmisión: DSG (DQ500)
Híbrida: –
 Kit mantenimiento caja de cambios automática
Vehículos:
 Audi, Seat, Skoda, VW



EST-5961308077

Tipo transmisión: 5HP30
Híbrida: –
Versión: Kit con aceite
Vehículos:
 Alpina, Aston Martin, Bentley, BMW, Rolls-Royce



EST-5961308078

Tipo transmisión: 5HP30
Híbrida: –
Versión: Kit sin aceite
Vehículos:
 Alpina, Aston Martin, Bentley, BMW, Rolls-Royce



EST-5961308284

Tipo transmisión: 9 G-Tronic
Híbrida: –
Versión: Kit sin aceite
Vehículos:
 Mercedes



EST-5961308371

Tipo transmisión: 5 G-Tronic
Híbrida: –
Versión: Kit con aceite
Vehículos:
 Mercedes



EST-5961308372

Tipo transmisión: 7 G-Tronic
Híbrida: –
Versión: Kit con aceite
Vehículos:
 Mercedes

Kits de mantenimiento cajas ZF



EST-5961308373

Tipo transmisión: DSG (0B5)
Híbrida: –
 Kit mantenimiento caja de cambios automática
Vehículos:
 Audi



EST-5961308375

Tipo transmisión: 9 G-Tronic
Híbrida: –
 Versión: Kit con aceite
Vehículos:
 Mercedes



EST-5961308407

Tipo transmisión: 6-speed AT (09D)
Híbrida: –
 Versión: Kit sin aceite
Vehículos:
 Audi, Porsche, VW



EST-5961308408

Tipo transmisión: 6-speed AT (09G A)
Híbrida: –
 Versión: Kit sin aceite
Vehículos:
 Audi, Seat, Skoda, VW



EST-5961308409

Tipo transmisión: 6-speed AT (09G B)
Híbrida: –
 Versión: Kit sin aceite
Vehículos:
 Audi, Seat, Skoda, VW



EST-5961308410

Tipo transmisión: 6-speed AT (09K)
Híbrida: –
 Versión: Kit sin aceite
Vehículos:
 VW



EST-5961308411

Tipo transmisión: 6-speed AT (09M)
Híbrida: –
 Versión: Kit sin aceite
Vehículos:
 Audi, VW



EST-5961308412

Tipo transmisión: 8-speed AT (0C8)
Híbrida: –
 Versión: Kit sin aceite
Vehículos:
 Audi, Porsche, VW



EST-5961308444

Tipo transmisión: CVT 0AW
Híbrida: –
 Kit mantenimiento caja de cambios automática
Vehículos:
 Audi



EST-5961308601

Tipo transmisión: DSG (DQ250)
Híbrida: –
 Versión: Kit con aceite
Vehículos:
 Audi, Seat, Skoda, VW



EST-5961308602

Tipo transmisión: DSG (DQ500)
Híbrida: –
 Kit mantenimiento caja de cambios automática
Vehículos:
 Audi, Seat, Skoda, VW



EST-5961309120

Tipo transmisión: 7 G-Tronic
Híbrida: –
 Versión: Kit con aceite
Vehículos:
 Mercedes

Aceites Land Rover

Aceites para transmisión



STC50531LR 1 litro
Aceite para transmisiones automáticas 402.



STC4861 500 ml
Aceite para cajas de transferencia



STC9157 5 litros
LubeTech
Aceite API GL4, para caja de cambios manual MTF 94.



VYK000010 1 litro
Aceite para engranajes - MTF94



STC9158 1 litro
LubeTech
Aceite API GL4, para caja de cambios manual MTF94



STC4862G 1 litro
Texamatic 7045E
Aceite para transmisión automática. Proporciona protección de primer nivel para todas las aplicaciones en que se especifican productos del tipo Dexron III G, que ofrecen excelente protección a los sistemas de transmisión y dirección asistida.



LR006247G 1 litro
Castrol Syntrans Multivehicle 75W-90 es un aceite para transmisión manual SAE 75W-90 totalmente sintético recomendado para la mayoría de las transmisiones manuales donde se requieren lubricantes API GL-4



STC4863G 1 litro
Mobile ATF LT 71141
Aceite para transmisión automática. Adecuado para su uso en transmisiones automáticas y sistemas de dirección asistida



TYK500050G 1 litro
ZF Lifeguard Fluid
Este aceite sintético de alto rendimiento para transmisiones automáticas ha sido desarrollado y aprobado exclusivamente para transmisiones automáticas ZF.



IYK500010G 1 litro
Aceite para cajas de transferencia TF-0870 - OEM Utilícelo en una caja transfer para proporcionar una viscosidad estable.



TYK500010G 1 litro
Diferencial Castrol SAF-XO SAE 75W-90
Aceite para transmisión totalmente sintético para la mayoría de las transmisiones de turismos.



LR003156G 1 litro
El aceite para engranajes Castrol Axle EPX 80W-90 es un aceite para engranajes multi- grado de extrema presión que se basa en aceites minerales altamente refinados e incorpora aditivos de extrema presión, inhibidores de corrosión y oxidación y agentes antiespumantes.



LR019727LR 1 litro
Castrol Diferencial SAF Carbon Mod Plus SAE 75W-90
Aceite totalmente sintético para engranajes que se puede utilizar en ejes con diferencial de deslizamiento limitado.



LR024835G 1 litro
Castrol Syntrans FE 75W / API GL-4
Aceite para transmisión manual multivehículo.

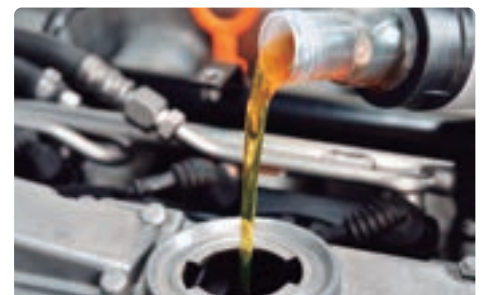

Aceites Land Rover

Aceites XD Britpart



DA1331 Britpart XD 10W-40 1 litro

Descripción del producto: Britpart XD 10W-40 es un aceite de motor semisintético multigrado fabricado con aditivos y aceites base de alta calidad para la eficiencia del combustible y un rendimiento superior para motores de gasolina y diésel de automóviles modernos y vehículos comerciales ligeros.

Aplicaciones: Britpart XD 10W-40 es adecuado para motores diesel y de gasolina con aspiración normal y turboalimentados en turismos y vehículos comerciales ligeros. Se puede mezclar con todos los aceites de motor sintéticos y minerales.

Niveles de rendimiento

- ACEA: A3 / B4
- VW: 502.00 / 505.00
- RN 0700/0710

Beneficios

- Mejor economía de combustible
- Excelente estabilidad a altas y bajas temperaturas
- Mejor consumo de petróleo y emisiones

Datos técnicos*

- SAE 10W-40
- Viscosidad cinemática @ 100 °C cSt 14.51
- Índice de viscosidad 152
- Punto de inflamación COC (°C) 220

DA1530 Britpart XD10W-40 5 litros

- API: SL / CF
- MB: 229.5

- Adecuado para una amplia gama de vehículos.
- Excelente arranque en frío

- Gravedad específica @ 15 °C (típica) 0.867
- Viscosidad cinemática @ 40 °C cSt 100.00
- Punto de fluidez °C -35
- TBN (mg KOH / g) 10.2



DA1333 Britpart XD 5W-30 1 litro

Descripción del producto: Britpart XD 5W-30 es un aceite de motor multi-grado totalmente eficiente y de bajo consumo de combustible que cumple con las últimas especificaciones de Ford.

Aplicaciones: Britpart XD 5W-30 es adecuado para vehículos de gasolina y diésel normalmente aspirados y turboalimentados, particularmente los vehículos más modernos. También se recomienda su uso en todos los motores Ford donde se especifique el último Ford WSS-M2C 913-D.

Niveles de rendimiento

- ACEA: A5 / B5
- STJLR 03.5003

Beneficios

- Capacidad de drenaje extendida
- Formulación para mantenerse en grado
- Mejora de la eficiencia del combustible
- Formulación totalmente sintética

Datos técnicos

- SAE 5W-30
- Viscosidad cinemática @ 100 °C cSt 11.29
- Índice de viscosidad 164
- Punto de fluidez °C -38

DA1529 Britpart XD 5W-30 5 litros

- API: SL / CF
- RN 0700

- Totalmente compatible con las especificaciones anteriores de WSS-M2C, 913-A, 913-B
- Excelente estabilidad a baja temperatura para caudales mejorados

- Gravedad específica @ 15 °C 0.850
- Viscosidad cinemática @ 40 °C cSt 66.51
- Punto de inflamación (COC °C) 220
- TBN (mg KOH / g) 8.9



DA1822 Britpart XD 20W-50 1 litro

DA1824 Britpart XD 20W-50 20 litros

Descripción del producto: Britpart XD 20W-50 es un aceite de motor a base de aceite mineral tradicional adecuado para su uso en turismos a gasolina y vehículos diesel de servicio ligero.

Aplicaciones: Las aplicaciones para el 20W-50 son vehículos de gasolina modelo más antiguos equipados con un filtro de aceite, especialmente vehículos V8 y 200Tdi / 300Tdi de alto kilometraje con consumo excesivo de aceite. También para ser utilizado en climas cálidos donde normalmente se recomienda un 15W-40. No apto para TD5 en adelante.

Niveles de rendimiento

- ACEA: A3 / B3
- MB: 229.1

Beneficios

- Rendimiento a alta temperatura
- Mantiene el rendimiento del aceite
- Alto nivel de limpieza del motor
- Minimiza el consumo de aceite

Datos técnicos

- 20W-50
- Viscosidad cinemática @ 100 °C cSt 18.2
- Índice de viscosidad 133
- Punto de fluidez °C -30

DA1823 Britpart XD 20W-50 5 litros

- API: SL / CF

- Protege contra el anillo pegado a altas temperaturas
- Excelente protección de control de lodos diseñada para automovilismo urbano
- Dispersante duradero, antidesgaste y protección contra la corrosión

- Gravedad específica @ 15 °C 0.885
- Viscosidad cinemática @ 40 °C cSt 153
- Punto de inflamación (COC °C) 220
- TBN (mg KOH / g) 9

Kits cambio de aceite para cajas con transmisión automática

Cajas de 6 velocidades

Para vehículos con caja de cambios automática 6HP26 o 6HP28 ZF de 6 velocidades. El kit consta de un conjunto de bandeja, líquido de transmisión, tornillos, manguito y tapones.

Adecuado para Discovery 3 y 4 Range Rover Sport (2005-2013) y L322

DA6085

Bandeja Britpart con aceite Ravenol

DA6085G

Bandeja ZF con aceite ZF

DA6085



Cajas de 8 velocidades

Para vehículos con caja de cambios automática ZF 8HP70 de 8 velocidades. El kit consta de un conjunto de bandeja, líquido de transmisión, tornillos y tapón. Adecuado para Discovery 4, Range Rover L322 (2010-2012) y Range Rover Sport (2010-2013 y 2014 en adelante)

DA6106

Bandeja Britpart con aceite ZF

Aceites Land Rover

Aceite aditivo para embrague

DA1356 1 litro
DA6296 Aditivo de aceite - Modificador de fricción 850 ml
 Este aceite es adecuado para su uso en embragues húmedos con sinterizado y placas orgánicas. El aceite proporciona excelentes características de fricción y evita el deslizamiento. Las propiedades de estabilidad al cizallamiento extremadamente buenas aseguran una lubricación óptima durante la vida útil del embrague. Este fluido se recomienda para los embragues de la unidad de control de acoplamiento AWD trasero Borg Warner Generation II-V utilizados en Land Rover.
 A las especificaciones de Land Rover EJ3219A509AA.



Aceite para compresor de A/C

Aceite refrigerante para compresores de aire acondicionado.
DA6296 850 ml
DA4967 250 ml



Aceites Ravenol



DA6289 1 litro
DA6288 5 litros
SFE Super Fuel Economy 5W-20
 Ravenol SFE 5W-20 es adecuado para todos los motores de gasolina y diesel que requieren un lubricante de bajo consumo de combustible de grado 5W20, y está especialmente desarrollado para cumplir con los requisitos de la última generación de vehículos Land Rover y Jaguar equipados con unidades 5.0L V8.



DA6376 1 litro
DA6377 5 litros
FLJ SAE 5W-30
 Ravenol FLJ SAE 5W-30 es un aceite de motor universal, especialmente ahorrador de combustible, y compuesto para motores de gasolina y diesel modernos con y sin turbocompresores, para usar en automóviles y furgonetas con intervalos de cambio de aceite prolongados.



DA6378 1 litro
DA6379 5 litros
VMO SAE 5W-40
 Aceite sintético universal para motores de baja fricción, especialmente desarrollado para motores diesel con bomba de chorro. También es adecuado para motores de gasolina y diesel en turismos y furgonetas con y sin turbocompresor. Debido a la composición específica, Ravenol VMO SAE 5W-40 es adecuado para varios de los últimos requisitos OEM.



DA6291 1 litro
DA6292 5 litros
FO 5W-30
 Ravenol FO 5W-30 es un aceite de motor de bajo consumo de combustible, producto especial para motores modernos de gasolina y diesel para automóviles de pasajeros.



DA1804 1 litro
DA1813 5 litros
Eco Synth ECS 0W-20
 Aceite de motor de baja fricción, totalmente sintético, para motores de gasolina y diésel modernos, incluidos modelos sobrealimentados, y para motores de inyección y vehículos híbridos en todas las condiciones de funcionamiento.



DA1805 1 litro
DA1814 5 litros
FDS 5W-30
 Aceite de motor de baja fricción totalmente sintético para motores de gasolina y diésel con y sin turbocarga e inyección directa. Ideal para usar en todas las condiciones de manejo, como en tráfico extremo de parada y marcha y conducción de autopistas de alta velocidad. Minimiza la fricción, el desgaste y el consumo de combustible.



DA1806 1 litro
DA1815 5 litros
FES 0W-30
 Aceite de motor de baja fricción totalmente sintético. Se recomienda para motores modernos de combustible y diesel, incluidos los modelos sobrealimentados, y para motores de inyección directa en todas las condiciones de funcionamiento. El uso de aditivos con bajo contenido de cenizas ofrece excelentes características de arranque en frío.



DA1807 1 litro
DA1816 4 litros
SSV Fuel Economy SAE 0W-30
 Logra un alto índice de viscosidad y un considerable ahorro de combustible gracias a su formulación con aceites base especiales y PAO. El excelente comportamiento de arranque en frío proporciona una seguridad de lubricación óptima durante la fase de funcionamiento en frío.



DA1808 1 litro
DA1817 5 litros
VDL 5W-40
 Aceite de motor totalmente sintético diseñado para motores diésel de alto rendimiento. Las propiedades mínimas de evaporación, la protección contra el desgaste muy alta y las características mejoradas de detergente y dispersante lo hacen adecuado para su uso en intervalos de drenaje prolongados y en las condiciones más duras.



DA1809 1 litro
DA1819 5 litros
VST 5W-40
 Utiliza las propiedades positivas del tungsteno para suavizar la estructura de la superficie del motor, mejorando significativamente la eficiencia mecánica. Esto garantiza un funcionamiento óptimo en todas las condiciones de conducción, paradas extremas e ir en tráfico intenso hasta la conducción de alta velocidad en autopistas.



DA6368 1 litro
DA6369 5 litros
TSi SAE 10W-40
 Es adecuado para su uso durante todo el año en automóviles modernos de gasolina y diesel. Para uso en vehículos turbo y no turboalimentados, motores diésel de inyección directa y multivalvulas y es compatible con catalizadores. Cumple y excede los requisitos de muchos OEM líderes, también cuenta con las aprobaciones del fabricante.



DA6380 1 litro
DA6381 5 litros
Turbo-C HD-C SAE 15W-40
 Se adapta perfectamente como aceite de motor en todas las estaciones para la flota mixta. Se puede usar en el sector de vehículos comerciales para la operación y el intervalo extendido de cambio de aceite (son posibles hasta 45.000 kilómetros) de acuerdo con las especificaciones del fabricante.

Aceites Land Rover



STC4863 1 litro
DA1579 20 litros
ATF 5/4 HP Fluid
 Ravenol ATF 5/4 HP Fluid está diseñado principalmente para su uso en las transmisiones automáticas ZF 4HP-series (4HP20, 4HP22, 4HP24) y 5HP-series (5HP18, 5HP19, 5HP24, 5HP30).



STC50531 1 litro
ATF JF506E Fluid
 Ravenol ATF JF506E está diseñado principalmente para su uso en transmisiones automáticas de 5 velocidades JATCO JF506E, utilizadas en Land Rover Freelander.



TYK500010 1 litro
TYK500010-4L 4 litros
TYK500010-20L 20 litros
VSG 75W-90 Gear Oil
 Adecuado para su uso en cajas de engranajes sincronizados y no sincronizados y en transmisiones y diferenciales de eje altamente estresados. Se utiliza en muchas aplicaciones de alto rendimiento, así como para uso en carretera en automóviles donde se desea la máxima protección y economía de combustible.



TYK500030 1 litro
TYK500030-4L 4 litros
MTF-2 75W-80 Gear Oil
 Ravenol MTF-2 SAE 75W-80 es ideal para garantizar el funcionamiento suave y eficiente de transmisiones modernas sujetas a cargas mecánicas y térmicas muy altas de aceites para engranajes, incluso en los intervalos de cambio de aceite más largos.



TYK500050 1 litro
TYK500050-4L 4 litros
TYK500050-20L 20 litros
TYK500050-208L 208 litros
ATF 6HP Fluid
 Desarrollado específicamente para uso en las últimas transmisiones de la serie ZF 6HP, 6HP19, 6HP21, 6HP26, 6HP28, 6HP32, 6HP34, también para transmisión automática de 5 velocidades de la serie 5HP. Es compatible con versiones anteriores de todas las versiones anteriores de ZF 4.



DA1345 20 litros
ATF 8HP
 Fluido de transmisión automática (ATF), producido con una mezcla de aceites de hidrocrack y PAO sintético junto con aditivos e inhibidores especiales para permitir una función suave y eficiente de las últimas transmisiones automáticas ZF de 8 velocidades y tiene un color verde para una fácil identificación.



DA6374 1 litro
DA6375 4 litros
ATF T-WS Lifetime Fluid
 Aceite de transmisión automática basado en la última tecnología sintética HC / HT y PAO. Debido a la formulación especial, la durabilidad es hasta el doble que la de un aceite ATF estándar comparable.



LR052059 1 litro
DGL SAE 75W-85 GL-5 LS
 Un aceite de transmisión hipoides basado en PAO multi-grado totalmente sintético que cumple con la especificación API GL-5 con un tratamiento de aditivos especialmente coordinado y propiedades de "deslizamiento limitado" para transmisiones manuales y ejes traseros.



DA1826 1 litro
MTF-1 SAE 75W-85
 Aceite de transmisión totalmente sintético de baja viscosidad para transmisiones manuales, cajas de transferencia y engranajes diferenciales. Combina un rendimiento sobresaliente en temperaturas extremas de frío y calor, incluso con intervalos de cambio de aceite prolongados.



DA1811 1 litro
DA1820 4 litros
MTF-3 75W
 Un aceite para engranajes totalmente sintético y de bajo consumo de combustible formulado con la última tecnología sintética PAO y sistemas de aditivos especiales para combatir cargas mecánicas y térmicas muy altas, incluso en los intervalos de cambio de aceite más largos.



LR019727 1 litro
Multi-disc Locking Differentials
 Lubricante semisintético. Los diferenciales de bloqueo multidisco Ravenol MDL se desarrollaron específicamente para su uso en diferenciales de deslizamiento limitado de láminas.



DA1569 300 ml
AWD-H Fluid
 Aceite de transmisión especial de alto rendimiento adecuado para unidades de control de acoplamiento AWD traseras. El aceite Ravenol AWD-H debe cambiarse cada 60.000 km. para evitar daños al tren motriz.



DA6372 1 litro
DA6373 4 litros
ATF Dexron D II
 Fue desarrollado para su uso en transmisiones automáticas, mecanismos de dirección hidráulica, convertidores y transmisiones de potencia y puede usarse como un ATF universal (fluido de transmisión automática) para todos los vehículos y máquinas de trabajo.



LR022460 1 litro
LR002748 1 litro
ATF T-IV Fluid
 Se desarrolló principalmente para su uso en las últimas transmisiones Aisin Warner y Toyota que se encuentran en muchos vehículos europeos y japoneses modernos, y su formulación versátil significa que también se puede usar para reemplazar T, T-II y T-III más antiguos, así como cumplir con muchos otros requisitos del fabricante.



STC4862 1 litro
ATF Dexron IIIH
 Para usar en transmisiones automáticas con embrague de bloqueo del convertidor controlado electrónicamente, pero también es adecuado para su uso como ATF universal y líquido de dirección asistida, especialmente cuando Dexron III es la especificación requerida y es compatible con versiones anteriores para Dexron II aplicaciones.



LR003156 1 litro
EPX SAE 80W-90 GL
 Ravenol Getriebeöl EPX SAE 80W-90 GL 5 es compatible con todos los aceites de transmisión de marca. En caso de cambiar a Ravenol EPX SAE 80W-90 GL 5, no es necesario lavarlo. Se puede utilizar en transmisiones manuales, transmisiones por eje, transmisiones distribuidoras e intermedias en vehículos y máquinas de trabajo.



IYK500010 1 litro
IYK500010-20L 20 litros
Transfer Fluid TF-0870
 Ravenol Transfer Fluid TF-0870 fue desarrollado para su uso en cajas de transferencia y proporciona una viscosidad estable incluso bajo las cargas más altas.



Aceites ZF



Tipo: **ZF LifeGuard Fluid 5**
 Ref.: **EST-S671090170009**
 Capacidad: **1 litro**
 Cruces OE:
 Audi: G 052162A1 / G 052162A2 / G 052162A6
 BMW: 83 22 2 344 206 / 83 22 9 407 807
 Jaguar: JLM 20238
 Mercedes: A 001 989 22 03
 Porsche: 999 917 547 00
 ZF: S671 090 171 / S671 090 172



Tipo: **ZF LifeGuard Fluid 7.2 MB AFT**
 Ref.: **EST-5961307352009**
 Capacidad: **1 litro**
 Cruces OE:
 Mercedes: 000 989 44 04 11 / 000 989 69 05 /
 001 989 77 03 / 001 989 77 03 11 /
 A 000 989 44 04 11 / A 000 989 69 05 /
 A 001 989 77 03 / A 001 989 77 03 11



Imagen usada como referencia

Tipo: **ZF LifeGuard Fluid 5**
 Ref.: **EST-AA02214229000**
 Capacidad: **10 litros**
 Cruces OE:
 Audi: G 052162A1 / G 052162A2 / G 052162A6
 BMW: 83 22 2 344 206 / 83 22 9 407 807
 Jaguar: JLM 20238
 Mercedes: A 001 989 22 03
 Porsche: 999 917 547 00
 ZF: S671 090 171 / S671 090 172



Tipo: **ZF LifeGuard Fluid 7.4 DCT**
 Ref.: **EST-5961308591009**
 Capacidad: **1 litro**
 Cruces OE:
 Audi: G 052 182 A2
 Seat: G 052 182 A2
 Skoda: G 052 182 A2
 Volkswagen: G 052 182 A2



Tipo: **ZF LifeGuard Fluid 6**
 Ref.: **EST-671090255009**
 Capacidad: **1 litro**
 Cruces OE:
 Aston Martin: 4G4319A509/AA/S
 Audi: G 055005A2
 Bentley: PY112995PA
 BMW: 83 22 2 305 396
 Jaguar: Jaguar Fluid 8432
 Land Rover: TYK500050
 Maserati: # 219549



Tipo: **ZF LifeGuard Fluid 8**
 Ref.: **EST-S671090312009**
 Capacidad: **1 litro**
 Cruces OE:
 Alfa Romeo: 00K68157995AA / 68157995AA
 Aston Martin: FD33-19509-AA/S
 Audi: G 060 162 A2
 BMW: 83 22 2 152 426 / 83 22 2 305 397
 Fiat: 00K68157795AB / 00K68157995AA
 Lancia: 00K68157995AA / 68157995AA
 Porsche: 000 043 210 54
 Volkswagen: G 060 162 A2



Imagen usada como referencia

Tipo: **ZF LifeGuard Fluid 6**
 Ref.: **EST-AA02214411000**
 Capacidad: **10 litros**
 Cruces OE:
 Aston Martin: 4G4319A509/AA/S
 Audi: G 055005A2
 Bentley: PY112995PA
 BMW: 83 22 2 305 396
 Jaguar: Jaguar Fluid 8432
 Land Rover: TYK500050
 Maserati: # 219549



Imagen usada como referencia

Tipo: **ZF LifeGuard Fluid 8**
 Ref.: **EST-AA02214225000**
 Capacidad: **10 litros**
 Cruces OE:
 Alfa Romeo: 00K68157995AA / 68157995AA
 Aston Martin: FD33-19509-AA/S
 Audi: G 060 162 A2
 BMW: 83 22 2 152 426 / 83 22 2 305 397
 Fiat: 00K68157795AB / 00K68157995AA
 Lancia: 00K68157995AA / 68157995AA
 Porsche: 000 043 210 54
 Volkswagen: G 060 162 A2



Tipo: **ZF LifeGuard Fluid 7.1 MB AFT**
 Ref.: **EST-5961307351009**
 Capacidad: **1 litro**
 Cruces OE:
 Mercedes: 000 989 08 04 11 / 000 989 68 05 /
 000 989 68 05 11 / 000 989 68 05 13 /
 001 989 68 03 / A 000 989 08 04 11 /
 A 000 989 68 05 / A 000 989 68 05 11 /
 A 000 989 68 05 13 / A 001 989 68 03



Tipo: **ZF LifeGuard Fluid 8.2 DCT**
 Ref.: **EST-671090545009**
 Capacidad: **1 litro**
 Cruces OE:
 Bentley: G 052 524 B2
 Porsche: 000 043 210 44

Aceites ZF



Tipo: **ZF LifeGuard Fluid 9**
 Ref.: **EST-AA0150000109**
 Capacidad: **1 litro**
 Cruces OE:
 Audi: G 065 162 A2
 BMW: 2 289 720 / 5 A12 A00 / 83 22 2 289 720
 Honda: 08200-9017 / 08263-999-01HE
 Land Rover: LR023288
 Mercedes: 000 989 65 01 11 / 000 989 65 05
 Nissan: 999MP-MTR00P
 Renault: 7717 277 174
 Volkswagen: G 065 162 A2



Tipo: **ZF LifeGuard Hybrid 2**
 Ref.: **EST-0671090548009**
 Capacidad: **1 litro**
 Cruces OE:
 BMW: 5 A28 F03 / 83 22 5 A28 F03
 Land Rover: LR181789



Tipo: **ZF LifeGuard eFluid 1**
 Ref.: **EST-5961308181009**
 Capacidad: **1 litro**
 Cruces OE:
 Audi: G 052 527 A2 / G 055 524 A2 / G 060 190 A2
 BMW: 5 A1D 718 / 83 22 5 A1D 718
 Seat: G 052 527 A2
 Skoda: G 052 527 A2
 Tesla: 1135241-00-A / 1135241-02-A
 Volkswagen: G 052 527 A2



Tipo: **ZF LifeGuard Hybrid 3**
 Ref.: **EST-5961308374009**
 Capacidad: **1 litro**
 Cruces OE:
 Mercedes: 000 989 33 07 11 / 001 989 92 03 /
 001 989 92 03 09 / 002 989 06 03 /
 002 989 06 03 09 / 002 989 06 03 11 /
 002 989 06 03 12 / 002 989 06 03 13 /
 A 000 989 33 07 11 / A 001 989 92 03 /
 A 001 989 92 03 09 / A 002 989 06 03



Tipo: **ZF LifeGuard eFluid 2**
 Ref.: **EST-0671090534009**
 Capacidad: **1 litro**
 Cruces OE:
 BMW: 2 156 959 / 2 167 666 / 83 22 2 156 959 /
 83 22 2 167 666
 Land Rover: GX73-M1R564-AA
 Mercedes: 002 989 04 03 / 002 989 04 03 09 /
 002 989 04 03 11 / A 002 989 04 03 /
 A 002 989 04 03 09 / A 002 989 04 03 11
 Porsche: 000 043 207 29 / 000 043 305 13 /
 000 043 305 14



Tipo: **ZF LifeGuard Hybrid 4**
 Ref.: **EST-5961308625009**
 Capacidad: **1 litro**
 Cruces OE:
 Audi: G 055 540 A2
 BMW: 0 397 114 / 0 403 248 / 0 403 249
 Fiat: 9.55550-AV2
 Porsche: 000 043 206 24 / 958 300 540 00
 Seat: G 055 540 A2
 Skoda: G 055 540 A2
 Volkswagen: G 055 540 A2
 Volvo: 31256774 / 31256775 / 31256776



Tipo: **ZF LifeGuard Hybrid 1**
 Ref.: **EST-AA02836455009**
 Capacidad: **1 litro**
 Cruces OE:
 Audi: G 065 162 A2
 BMW: 2 289 720 / 5 A12 A00 / 83 22 2 289 720
 Honda: 08200-9017 / 08263-999-01HE
 Land Rover: LR023288
 Mercedes: 000 989 65 01 11 / 000 989 65 05
 Nissan: 999MP-MTR00P
 Renault: 7717 277 174
 Volkswagen: G 065 162 A2



Despiece cajas de transfer y diferenciales

Marca

Audi

Modelo

Q3 / TT

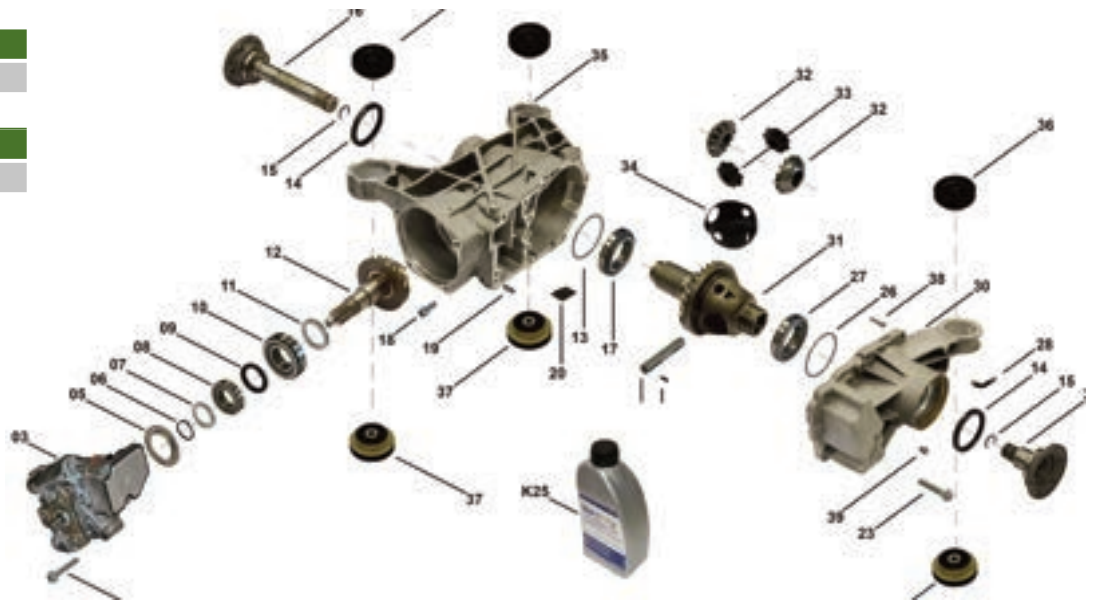

Marca

BMW

Modelo

X3

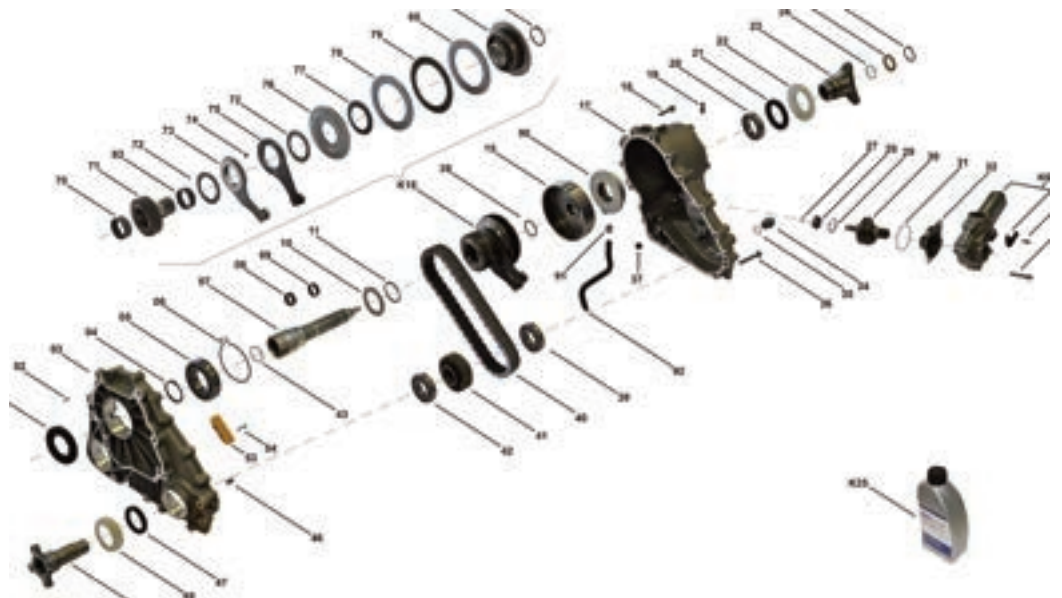

Marca

Land Rover

Modelo

Discovery / Range Rover

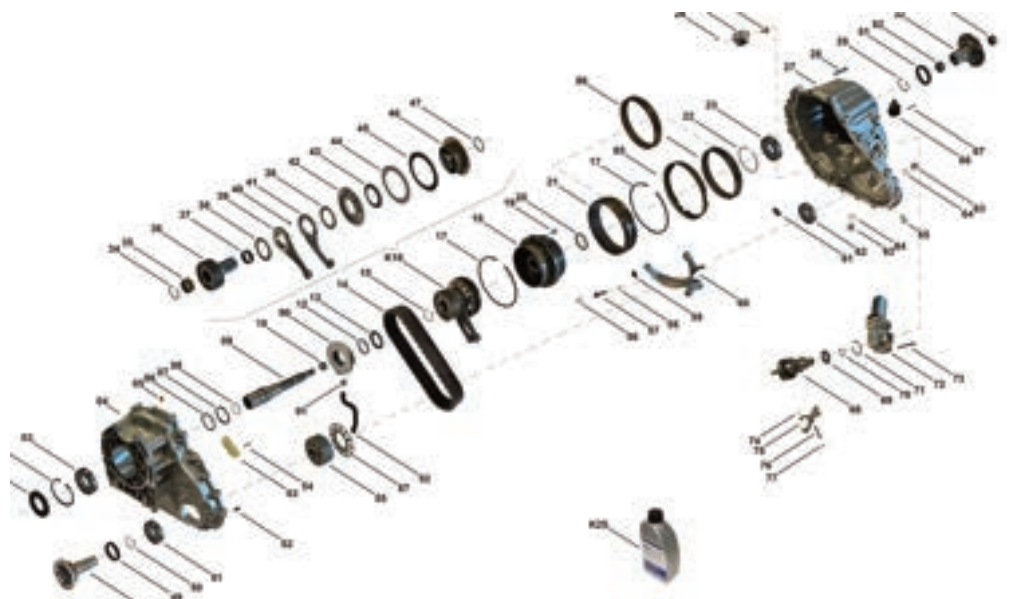

Cajas 4WD

EMBRAGUE CAJA TRANSFER



TT04-00-003

Kit piñón y
embrague



TT04-00-016

Kit discos
embrague



TT04-00-032

Base embrague.
Válido para
IAB500280E

KIT BRIDA CARDAN



TT04-00-021

Brida delantera

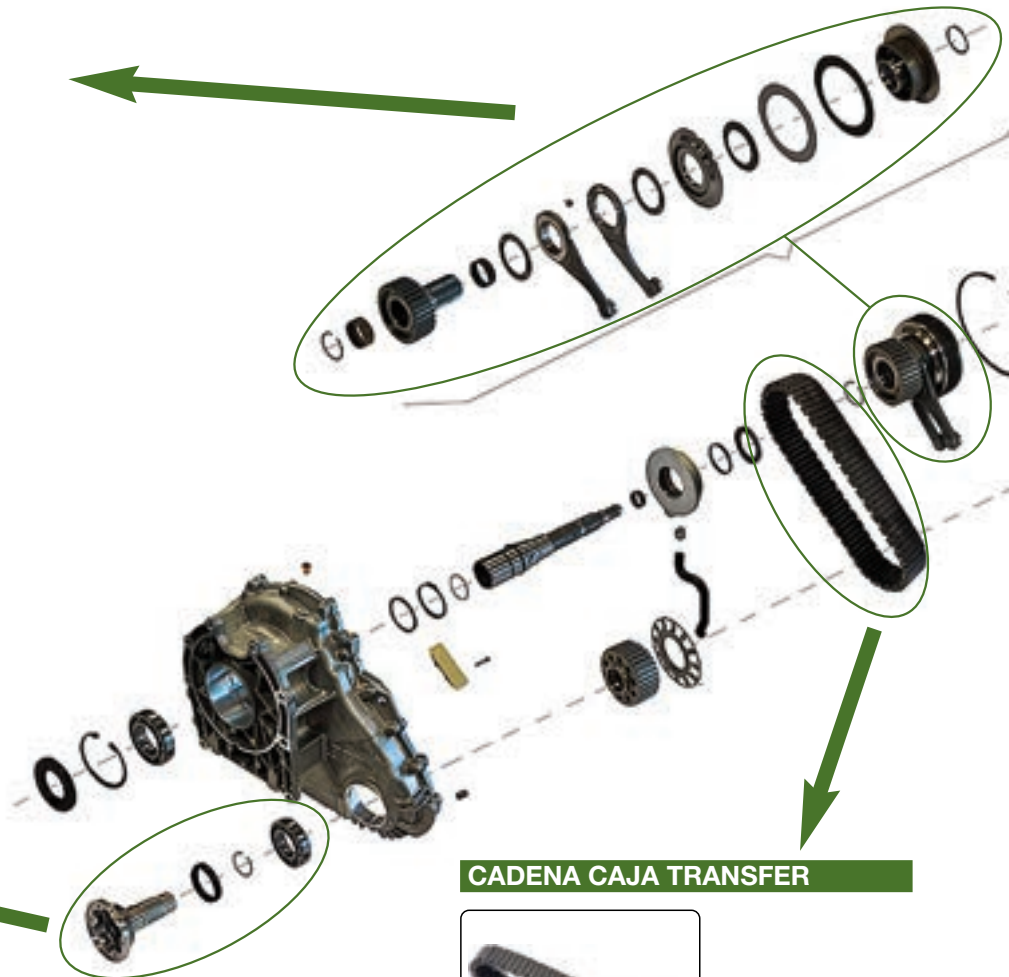

CADENA CAJA TRANSFER



TT04-00-017

Cadena



TT04-00-058

Anillo retén
engranaje
distribuidor
Land Rover



TT04-10-001

Actuador, caja de
distribución
BMW 3, 5, 6, 7, 8,
X3, X4, X5, X6, X7



TT04-10-004

Actuador, caja de
distribución
BMW 1, 2, 3, 4, 5,
6, 7, X4, X5 y X6



TT04-10-016

Actuador, caja de
distribución
BMW 3, 5.



TT04-10-020

Actuador, caja de
distribución
BMW X3, X5.



TT04-10-053

Brida
accionamiento
cardán
BMW

Cajas 4WD

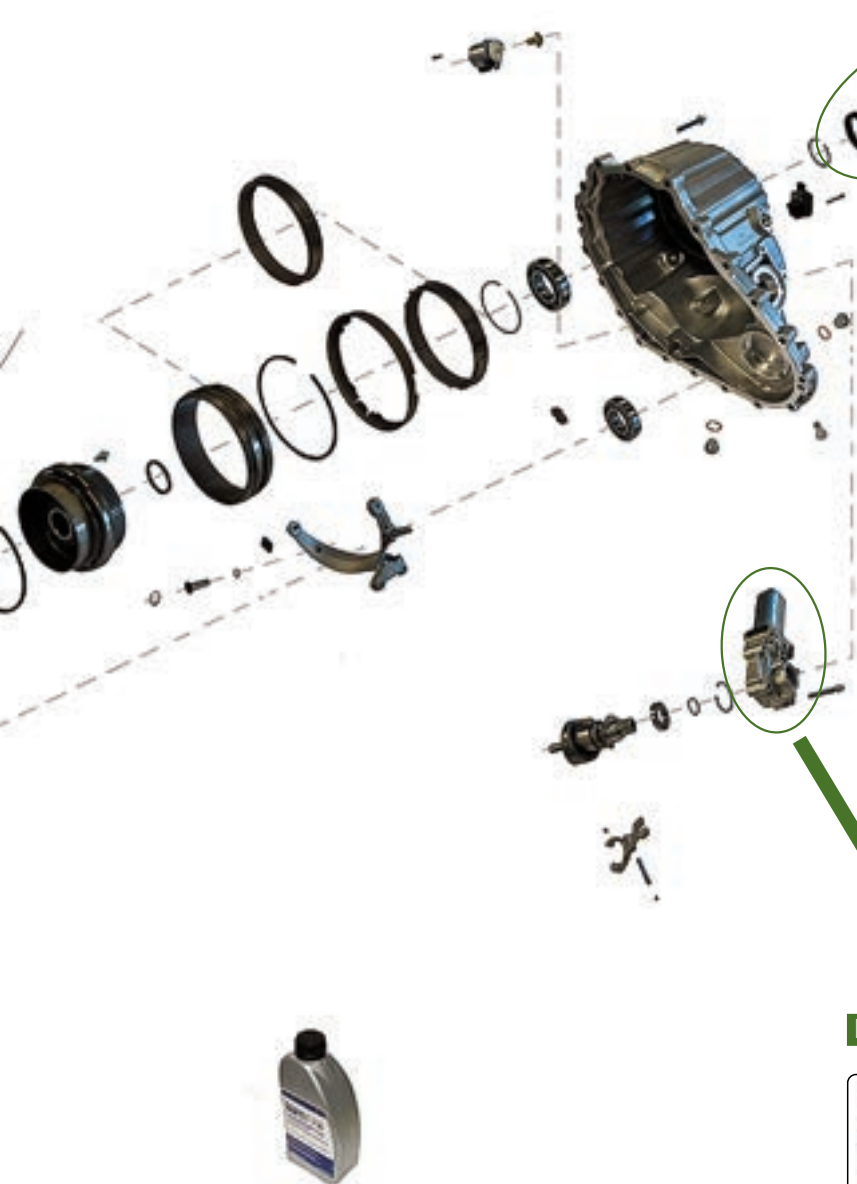

KIT BRIDA CARDAN



LR039528

Brida trasera

MOTOR ACCIONAMIENTO TRANSFER



TT04-00-013

Kit motor
accionamiento



TT04-10-055

Embrague
multidisco,
tracción total
BMW



TT04-10-069

Cadena
BMW X3



TT04-10-083

Placa base,
elemento de
sujeción del
embrague
BMW



TT04-10-167

Anillo retén,
engranaje
distribuidor
BMW



TT04-90-240

Filtro hidráulico,
transmisión
automática
Mercedes Benz



TT04-90-056

Cadena
Mercedes Benz
Clase GL, Clase M,
Clase R

Cajas cambio automático doble embrague



RENAULT CLIO



RENAULT MEGANE

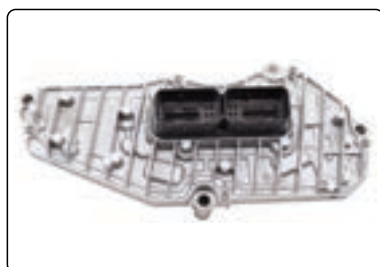

TT04-10-363

Unidad de control,
transmisión automática
Renault Megane III,
Scenic III, Fluence



TT04-10-416

Kit doble embrague
Renault Captur; Clio IV
Berlino; Clio IV Estate,
Duster, Megane IV & IV
Grandtour; Kadjar;
Megane III, Talisman,
Kangoo II; Laguna



TT04-10-417

Kit doble embrague
Renault Talisman,
Megane IV, Megane IV
Grandtour, Espace V;
Scenic V



TT04-33-037

Kit embrague
Mercedes 453



TT04-33-041

Embrague y Kit
Damper
Ford C-MAX, Focus,
Fusion, Galaxy,
S-MAX, Edge, Kuga,
Modeo, Transit,
Tourneo



TT04-33-227

Junta, carcasa
embrague
Renault Talisman,
Megane IV, Megane IV
Grandtour, Espace V,
Scenic V



TT04-47-026

Kit Mechatronic
Ford C-MAX, Fusion,
Mondeo, Galaxy, Edge,
Focus, Transit, Kuga

*Si no encuentra la referencia que busca,
consulte con nuestro Departamento de Ventas*

CONDICIONES DE VENTA Y GARANTIA

En la venta de una caja de cambio o de transferencias o motor reconstruido, se efectúa el cargo en depósito del valor del casco, que transcurridos 15 días de la venta de la misma, si no han sido devueltos se procederá a efectuar el pertinente cargo en cuenta del cliente. En la venta de una caja de cambio fuera del territorio español peninsular, el valor del casco será facturado con la caja de cambio y abonado en el momento de su devolución.

Las CAJAS DE CAMBIO o TRANSFERENCIA o MOTORES se entregan desnudas y sin lubricante.

El cliente usuario o el taller del montaje se compromete a rellenar el Certificado de montaje y hacerlo llegar a ESTANFI AUTOMOCION, en un tiempo máximo de 10 días.

Si la caja de cambio exteriormente tiene alguna variación en anclajes y varillajes o elementos exteriores, los gastos ocasionados en mano de obra por estos cambios, correrán a cargo del usuario de la caja de cambio.

Las cajas de cambio tendrán una garantía de 12 meses, sin límite de kilometraje.

Para que esta garantía sea otorgada será necesario que: Esté en poder de ESTANFI AUTOMOCION el certificado de montaje de la caja de cambio debidamente cumplimentado. En el momento de la avería se avisará por cuenta del taller a la empresa ESTANFI AUTOMOCION, y se facilitará los datos necesarios para averiguar las causas o imputabilidad del defecto.

La garantía se limita exclusivamente a la sustitución o abono del importe de la caja de cambio o de transferencias, con la exclusión de responsabilidad por daños eventuales, reparación, instalación, etc.

La GARANTÍA NO CUBRE:

Las consecuencias de inmovilización del vehículo, los desplazamientos y las grúas.

Los lubricantes que deben sustituirse en las revisiones. Las reclamaciones por calentamiento indebido de la caja de cambio o por rozamientos bruscos.

Las pérdidas de aceite en juntas y retenes como consecuencia de un calentamiento indebido de la caja de cambio.

La GARANTÍA QUEDA ANULADA en los siguientes casos: La manipulación interna o externa de la caja o del motor sin autorización previa de ESTANFI AUTOMOCION.

Montaje de la caja de cambio o motor sin certificado de montaje. Cuando el certificado de montaje no sea enviado a ESTANFI AUTOMOCION en el tiempo acordado.

Cuando se haya observado mal uso o uso inadecuado de la caja de cambio o motor provocando calentamientos excesivos. Cuando se observen fugas de aceite en retenes o juntas provocadas por calentamientos excesivos.

Cuando haya de sustituirse piezas como consecuencia del mal uso de los mandos, error u omisión de las señales peligrosas, elementos de control o de ruidos externos anormales, aunque sea necesaria su sustitución como consecuencia de una avería imputable al proceso de reconstrucción.

La GARANTÍA ENTRA EN VIGOR, a partir de la fecha de emisión de la factura correspondiente.

PORTES: Los portes de envío de la caja o motor y reenvío del casco de la caja de cambio usada correrán a cargo del cliente usuario del vehículo donde se monta la caja.

El comprador de la caja o motor renuncia a su fuero propio y acuerda con ESTANFI AUTOMOCION someter cuantas divergencias pudieran surgir con motivo de la interpretación o incumplimiento de estas condiciones, a la jurisdicción de los Tribunales y Juzgados de Barcelona.

Al formalizarse la venta se entenderá que son aceptadas todas las condiciones aquí expresadas.



*Larga tradición en la
gestión y fabricación de
engranajes para cajas
de cambio*

Desde 1980

ESTANFI
AUTOMOCION



**Disponemos de un stock de más de 400
modelos de cajas de cambio y transfer.**

El mayor stock de España

Entregas en 24 horas

Portes pagados

C/. Xaloc, 16 • Políg. Ind. Llevant • 08213 POLINYÀ - (BARCELONA) ESPAÑA
Tels. 902 125 025 - (34) 93 579 90 30 • info@estanfi.com • www.estanfi.com

